

# Tote bag | ac-0001

With inside pocket, French seams on the outside and extra decoration (without embroidery)

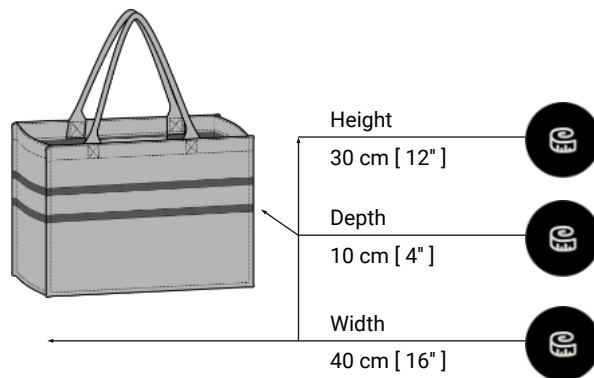

# Tote bag | ac-0001



## Required material



Fabric for bag

Width 140 cm [ 55" ]  
Lenght ~85 cm [ 33,5" ]



Matching thread

## Basic equipment

Printer, paper, tape, needlework scissors, sewing machine, iron, ironing cloth/board, tailor's scissors, tape measure, ruler, tailor's chalk, marking pens, pencil, pins, sewing needles or clips.



**Tipp! For a stiffer bag**

See page 5

# Cutting layout | ac-0001

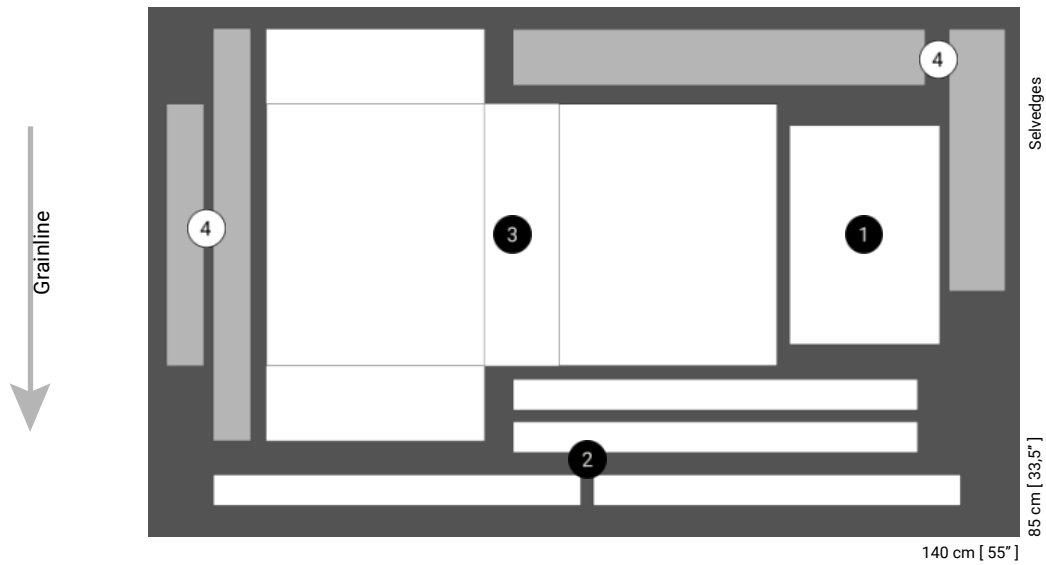

**The pattern contains  
 all necessary seam allowances!**  
 1cm [ 0,4' ]



**Tip! for patterned fabrics**

Pattern piece 3 is the complete bag pouch.  
 If you have chosen a patterned fabric, consider beforehand whether you should arrange and cut the front, back, bottom and side pieces separately so that your pattern is not upside down on one side of the bag.



**Tipp! For the decoration**

You can leave out the decoration or sew it from other matching fabrics.



Right side of fabric



Wrong side of fabric

# Pattern pieces | ac-0001

Please draw the following pieces straight onto the fabric

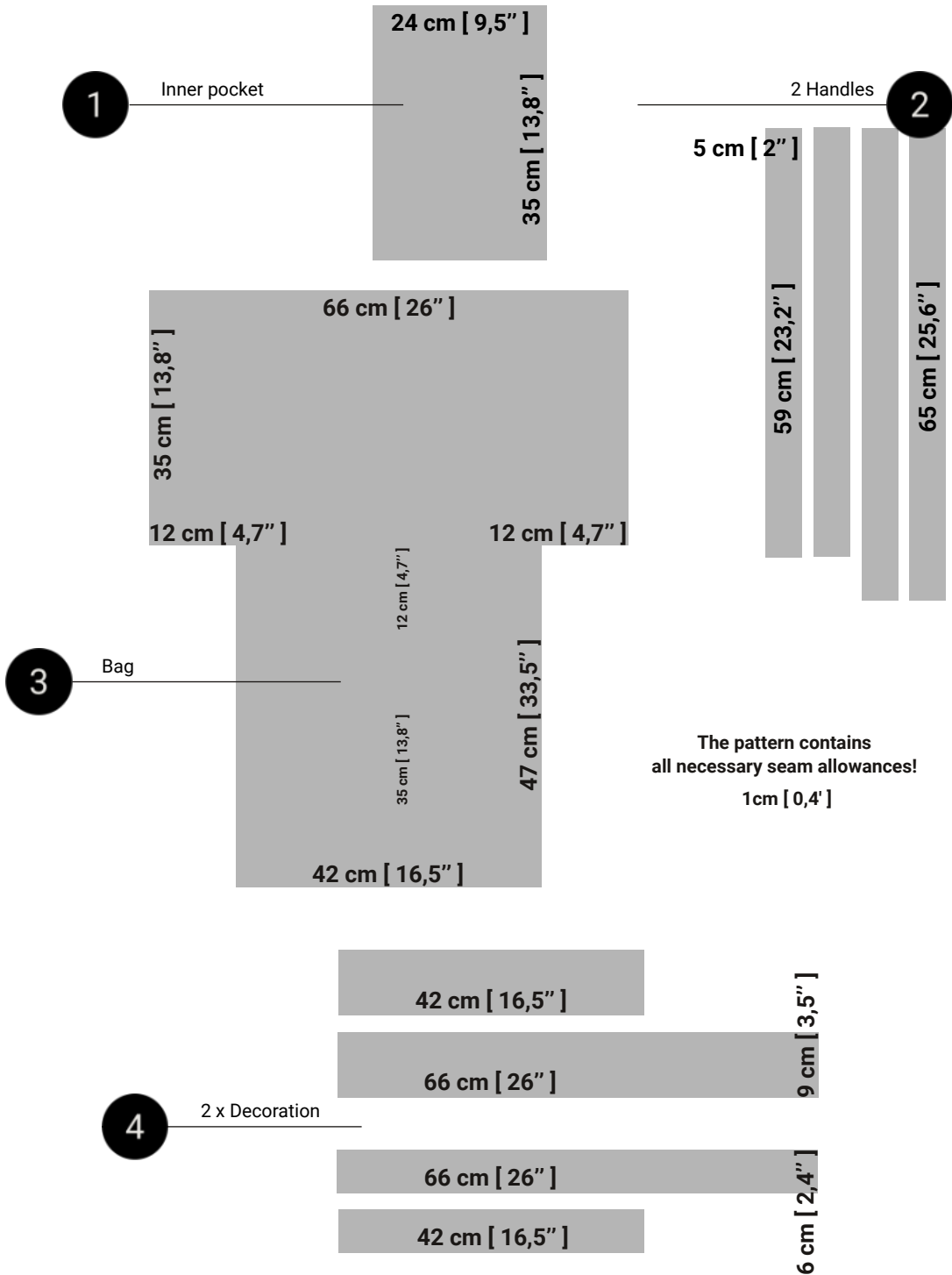

# Short version | Sewing instruction | ac-0001

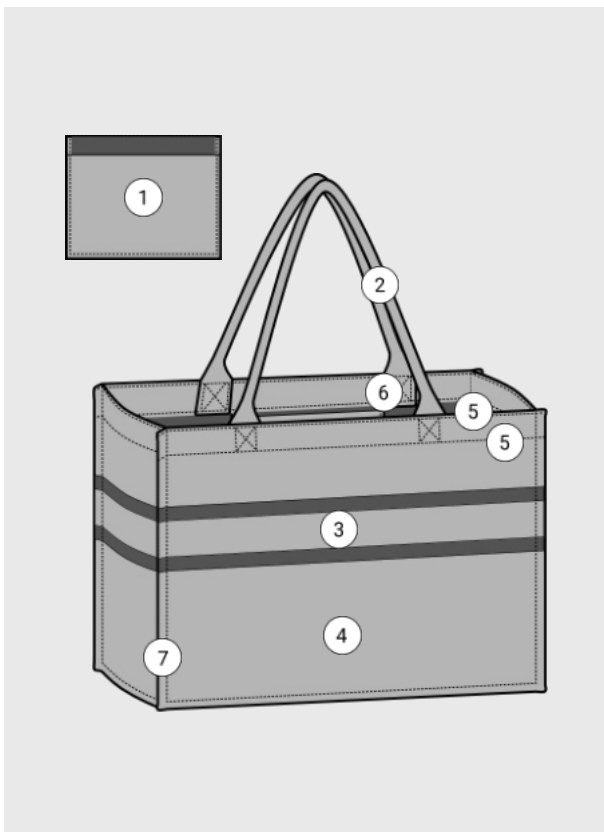

## Working steps

- 1. Inner pocket** Sew with a French seam on the outside. Leave an edge of approx. 3 cm at the top.
- 2. Handles** Right sides together, short to long, Sew long edges (1 cm). Turn, press. Press short overlapping edges 1 cm inwards and again by 3 cm. Topstitch all around, close to the edge. Fold long edges over each other and topstitch in seam ditch, leaving 6 cm on all 4 ends.
- 3. Decoration** Press lengthwise edges 1 cm over and topstitch the 2 layers on the bag pieces. Caution! Seam allowances not too thick
- 4. Bag** With wrong sides facing, sew bag, 1cm seam allowance. Trim seam to 3mm.
- 5. Bag edge** Press over 1 cm and again 3 cm inward. Place the inner pocket in the center of one of the long sides under the pressed edge and pin in place. Topstitch the edge all around. Topstitch the top edge again.
- 6. Handles** On the inside of the facing, 12 cm from the center, stitch in place. Use the seam ditch.
- 7. French seam** Turn pocket right side out. Topstitch all edges at 7 mm, enclosing seam allowances.



Working on the wrong side

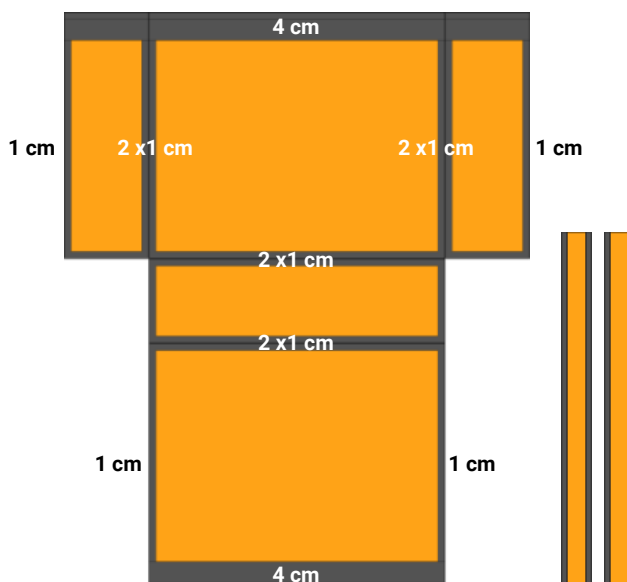

### Tipp! For a stiffer bag

After cutting, iron Vlieseline H250 onto the pocket fabric and the shorter strips of the handles.



### Attention!

Not on the seam allowances!

# Sewing instruction | ac-0001

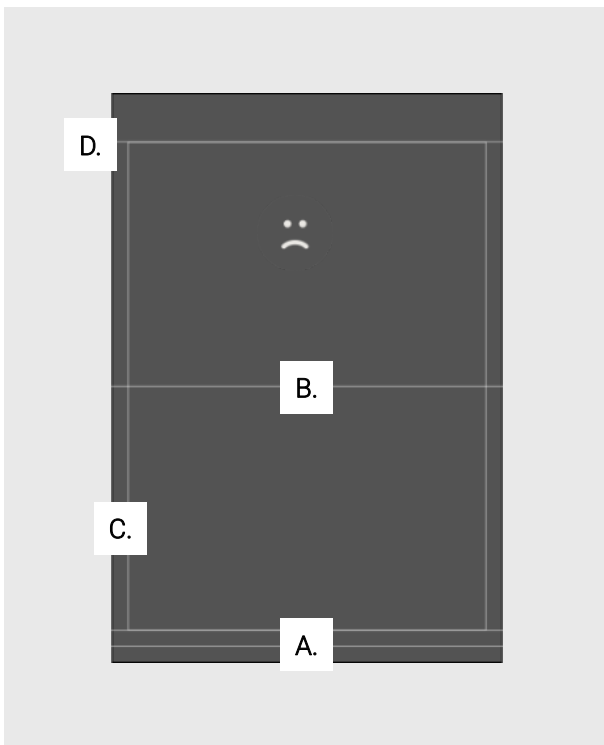

## 1. Inner pocket with french seam on the outside

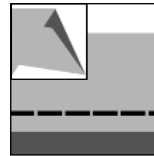

### A. Short edge

Fold 2 x 1 cm inwards, iron, topstitch

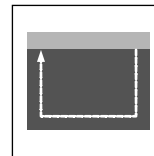

### B. Fold

Fold right sides together. Leave 2.5 cm at the top.



### C. Close the sides

Sew, 1.5 cm seam allowance. Only on the folded part!

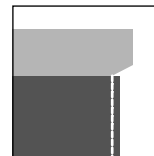

### D. Cut in & trim

Cut to the seam. Cut back seam allowance

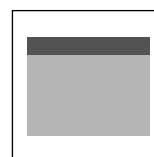
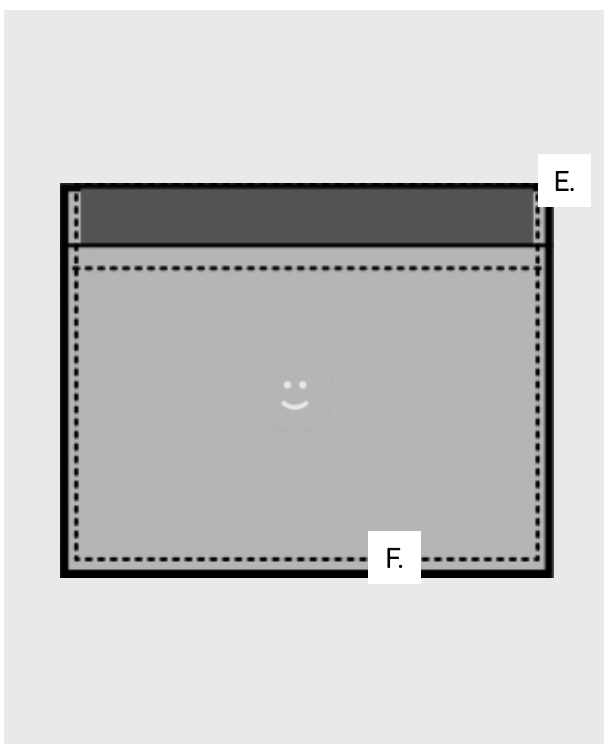

### Turn & iron

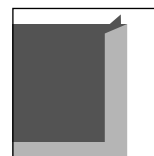

### E. Fold

Edge 2 x 1 cm inwards, iron

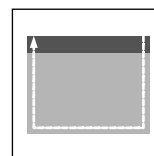

### F. Topstitch close to the edge

Include the seam allowance on the inside.



### Tip!

[How-To-Video „French Seams“](#)

# Sewing instruction | ac-0001

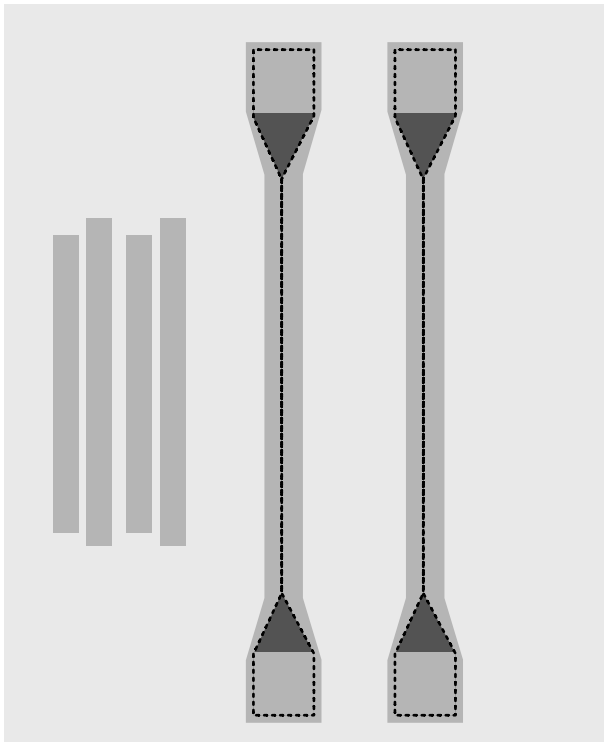

2. Handles 2 x

- A. Right sides together - short to long.**  
Sew long edges.
- B. Turn and press.**
- C. Short overlapping edges.**  
Press 1 cm inwards and again by 3 cm.
- D. Topstitch all around, close to the edge.**
- E. Fold long edges over each other.**  
Topstitch in seam ditch, leaving 6 cm on all 4 ends.

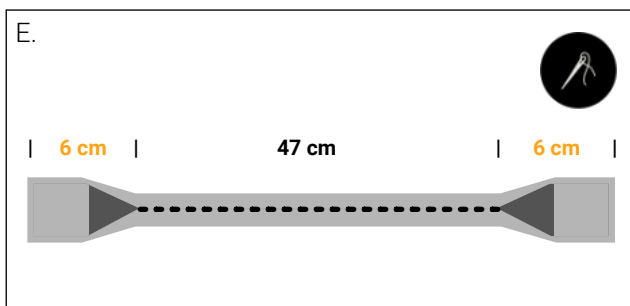
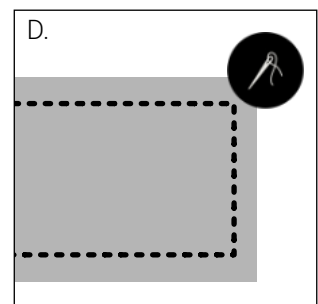
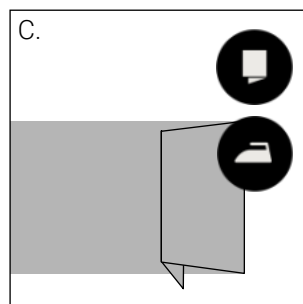
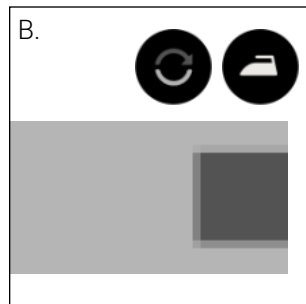
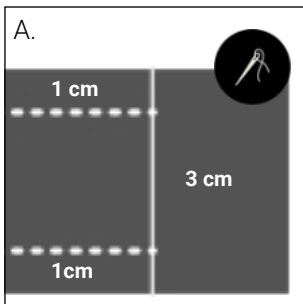

# Sewing instruction | ac-0001

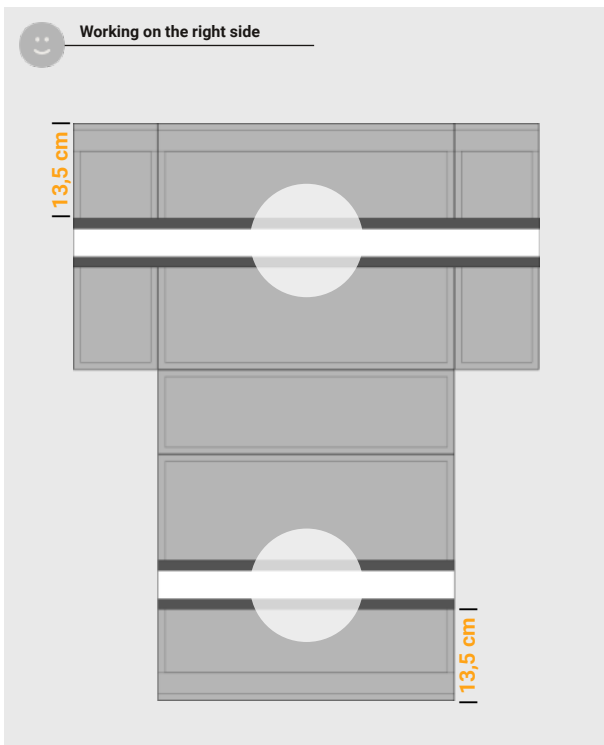

### 3. Decoration



**All lengthwise edges**

Iron 1 cm inwards.

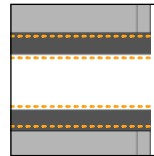

**Topstitch all strips in place**

See placement on the left.  
Attention! Seam allowances not too thick.

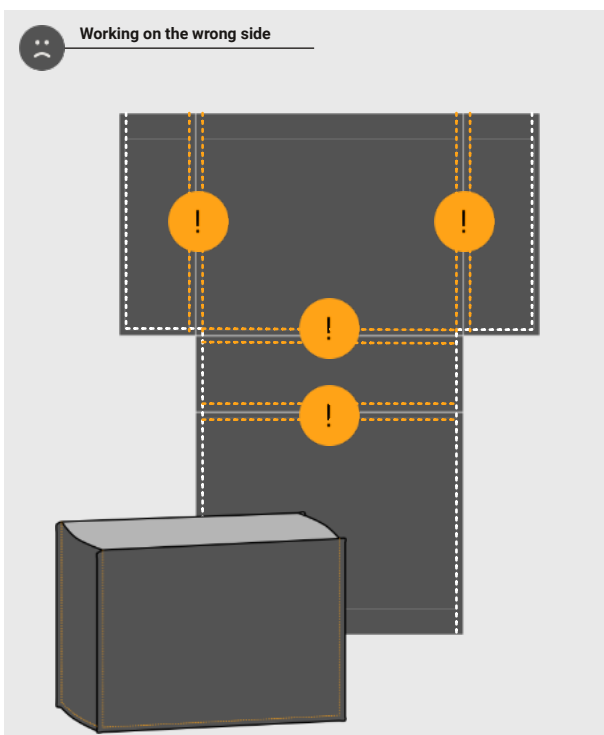

### 4. Bag

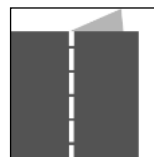

**Sew bag**

Right sides facing.  
1cm seam allowance.



**Seam allowance**

Trim to 3mm.



**Attention!**

A seam on the "unnecessary" sides too, otherwise the bag will fall apart when you cut back the seam allowance.



# Sewing instruction | ac-0001

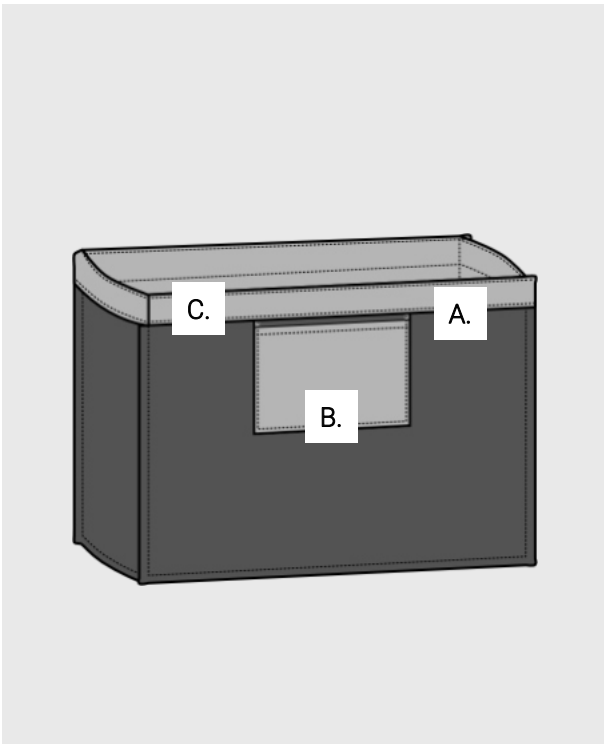

## 5. Bag edge

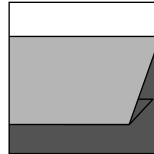

### A. Edge

Press over 1 cm and again 3 cm inwards.

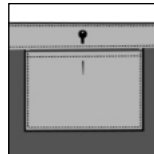

### B. Inner pocket

Place it in the center of one of the long sides under the pressed edge and pin in place.



### C. Edge

Topstitch the edge all around and again the top edge.

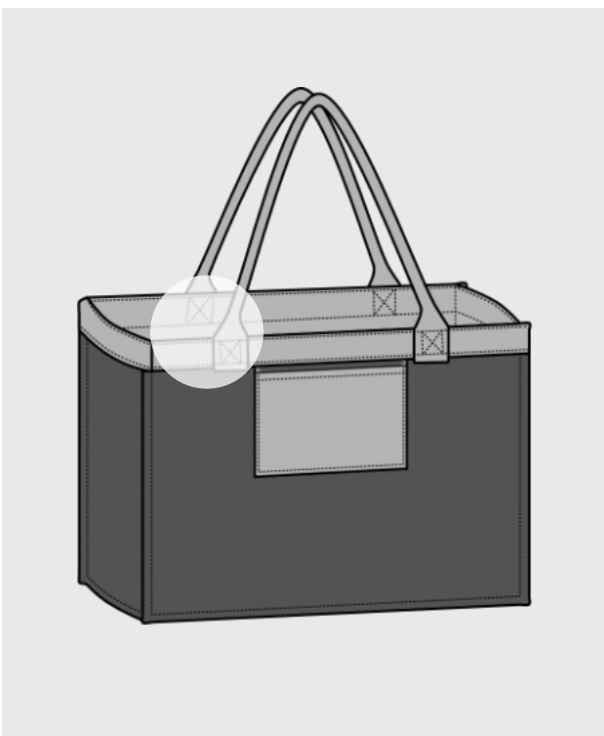

## 6. Handles

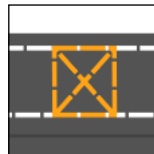

### Handles

12 cm from the center, stitch in place. Use the seam ditch.

# Sewing instruction | ac-0001

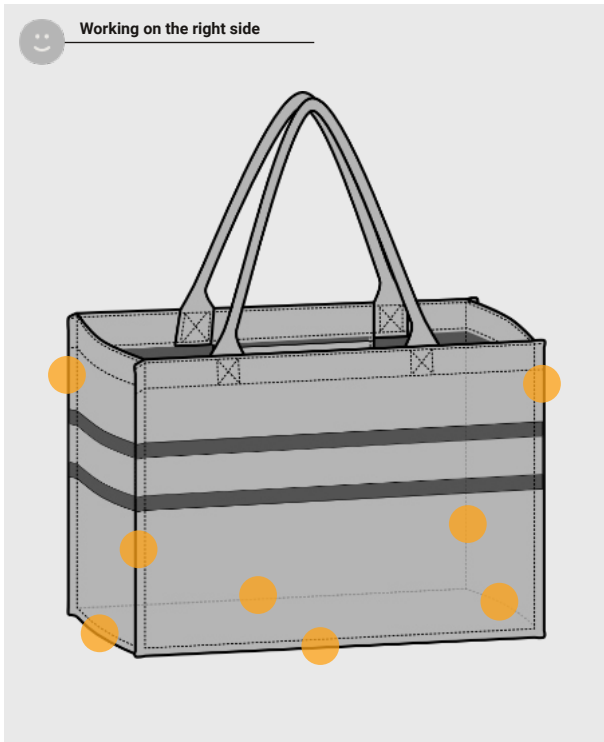

7. French seam on the outside

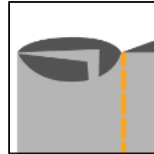

**Turn pocket right side out.**

Sew all remaining 8 edges at 7 mm.  
Enclose seam allowances.



**Tip!**

















[How-To-Video „French Seams“](#)



**Done!**

Congratulations.

# Glossary

	Fabric		Sewing
	Right „nice“ side		Serging
	Wrong side		Pin
	Fold		Cut
	Thread		Mark
	Seam tape		Measure
	Secure seam, sew or knot		Elastic
	Iron		Tip with or without link

# Things to know



### Cutting

Right "nice" fabric sides lie inside.



### Measured pieces

Drawing directly on the wrong side of the fabric.



### Baste, sew, topstich

Baste. Large stitches by hand or sewing machine.

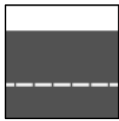

Sew, mostly on the wrong side of the fabric.

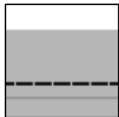

Topstitching, close to edges/seams. For flat edges or decoration. Mostly on the right side of the fabric.

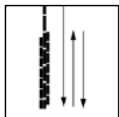

Secure seam = start/end sew a few stitches forward/backward.

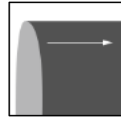

### Fold & Grainline

Fold = Edge of the folded fabric

Grainline = Weaving direction

= Arrow on pattern pieces.



### Cutting for beautiful seams



Trimming the seam allowances.

Cut curves several times.

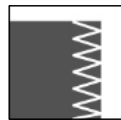

### Serging to avoid fraying

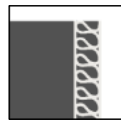

Serging seam allowances with zigzag stitch or overlock machine.