

Pants • Hose • Pantalón | tr-0002

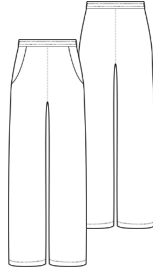

Printing layout • Druckübersicht • Plan de impresión

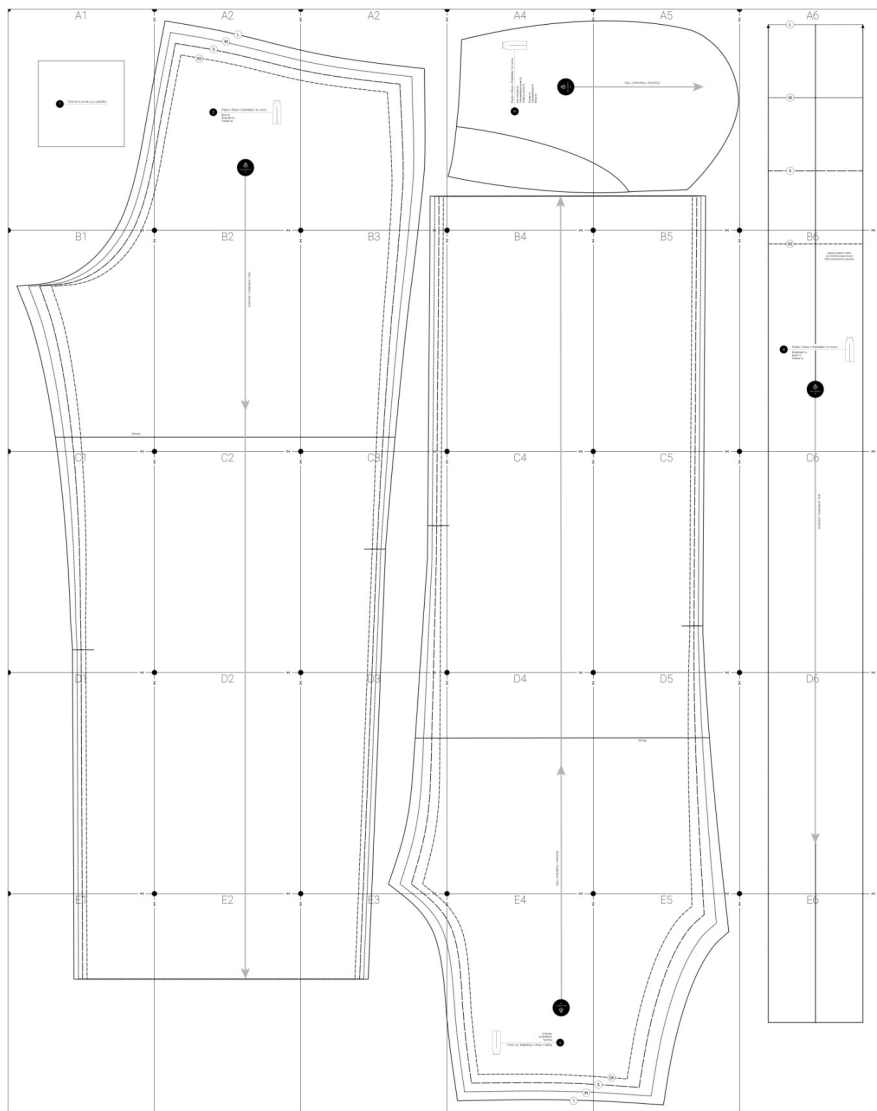

Print and assemble the pattern Schnitt drucken und zusammensetzen Imprimir y montar el patrón

I. Test

Print and check the page with the test square.

Drucken und überprüfen der Seite mit dem Test-Quadrat.

Imprime y comprueba la página con el cuadrado de prueba.

A4, 100% = 10 x 10 cm | 4 x 4 inches

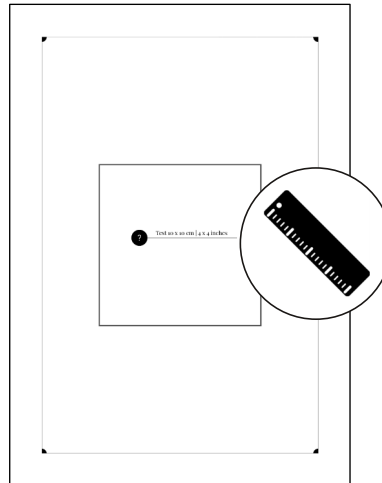

II. Print • Drucken • Impresión

Print all pages.

Cut & Glue in the marked places.

Drucken aller Seiten. Scheiden & kleben an den markierten Stellen.

Imprimir todas las páginas. Cortar & pegar en los puntos marcados.

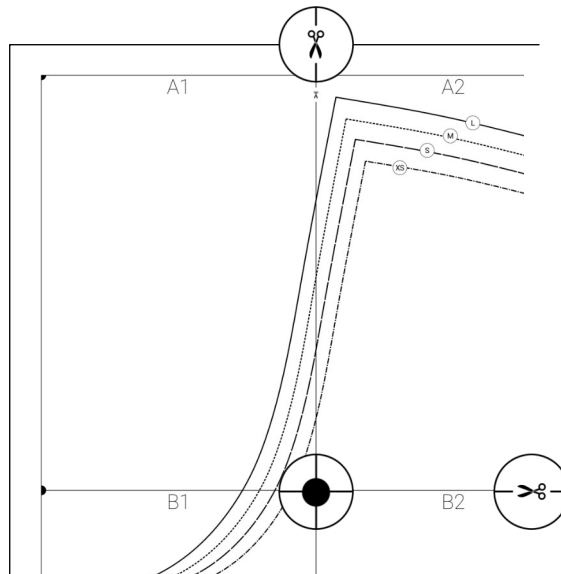

III. Size • Größe • Talla

Größe ausschneiden.
Cut out your size.
Cortar la talla.

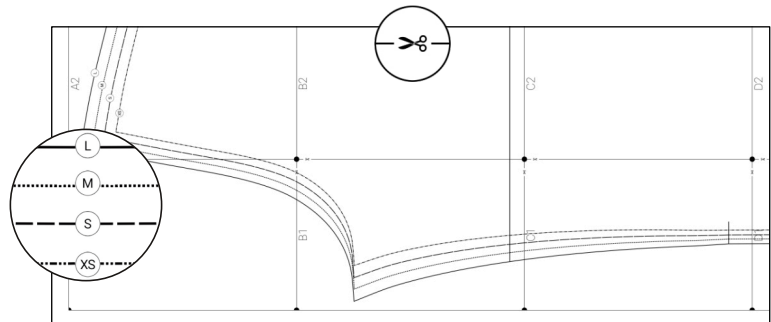

A1

?

Test 10 x 10 cm | 4 x 4 inches

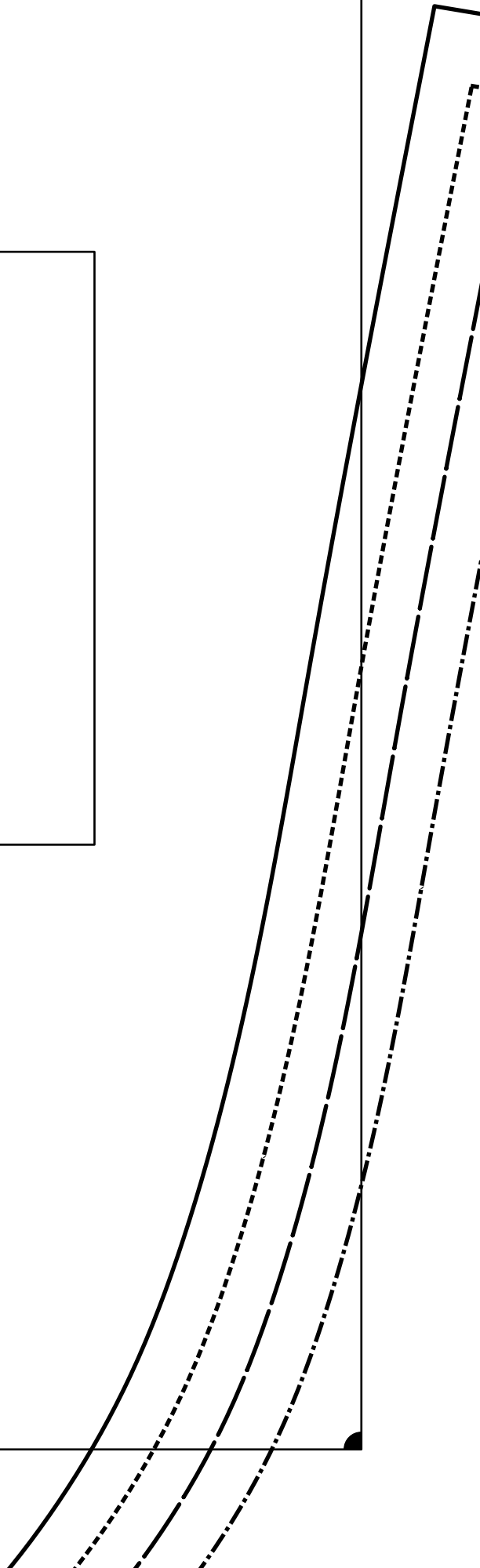

A2



XS

S

M

L

2

Pants • Hose • Pantalón | tr-0002

Back 2x
Hinterteil 2x
Trasero 2x



A3

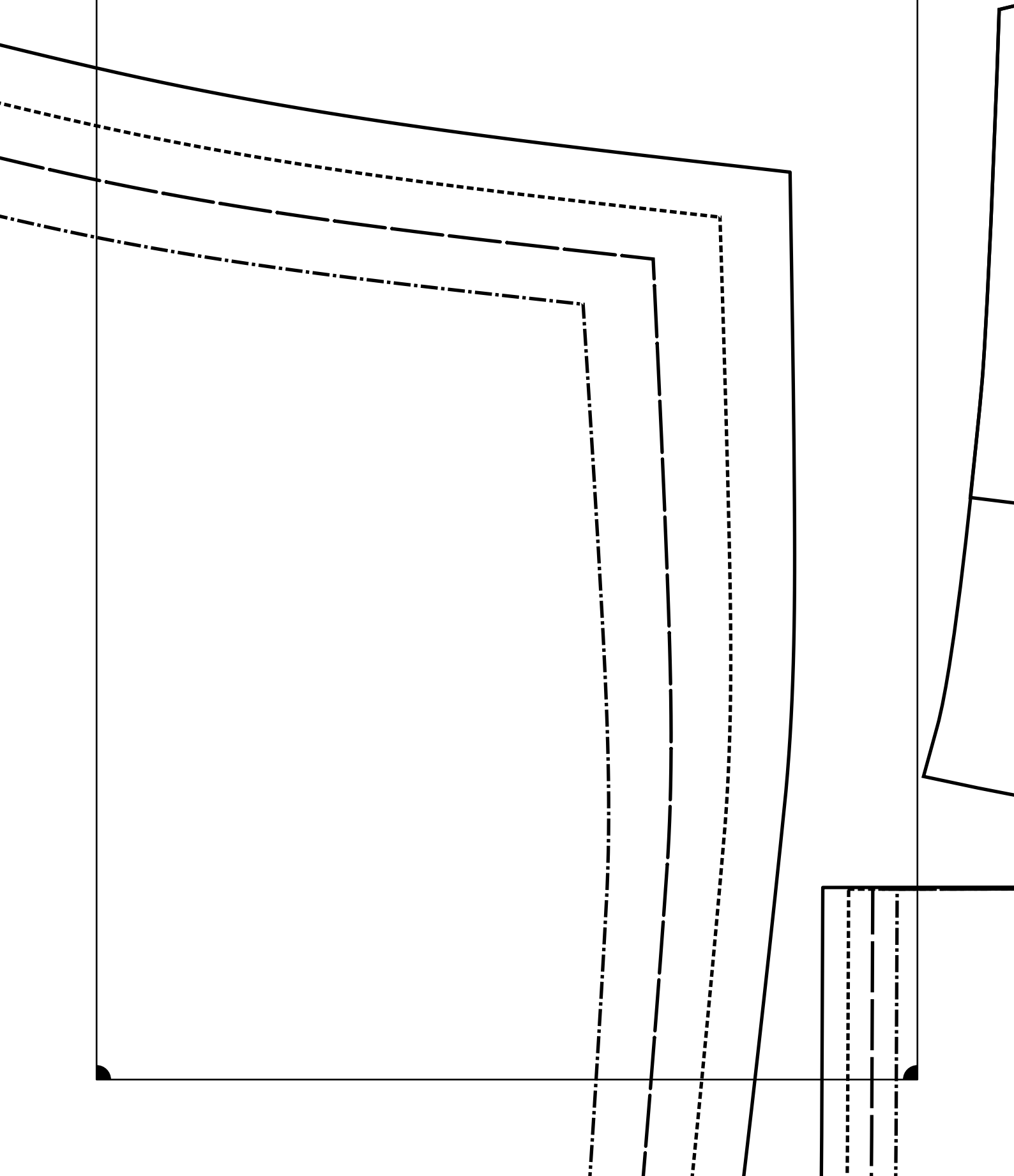

A4



3 **Pants • Hose • Pantalón | tr-0002**

Hip + Pocket 2x
Hüfte + Tasche 2x
Cadera + bolsa 2x

Pocket 2x
Taschenbeutel 2x
Bolsa 2x



faya patterns



A5



Grainline • Fadenlauf • Hilo

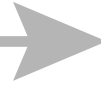

A6



L

M

S

XS

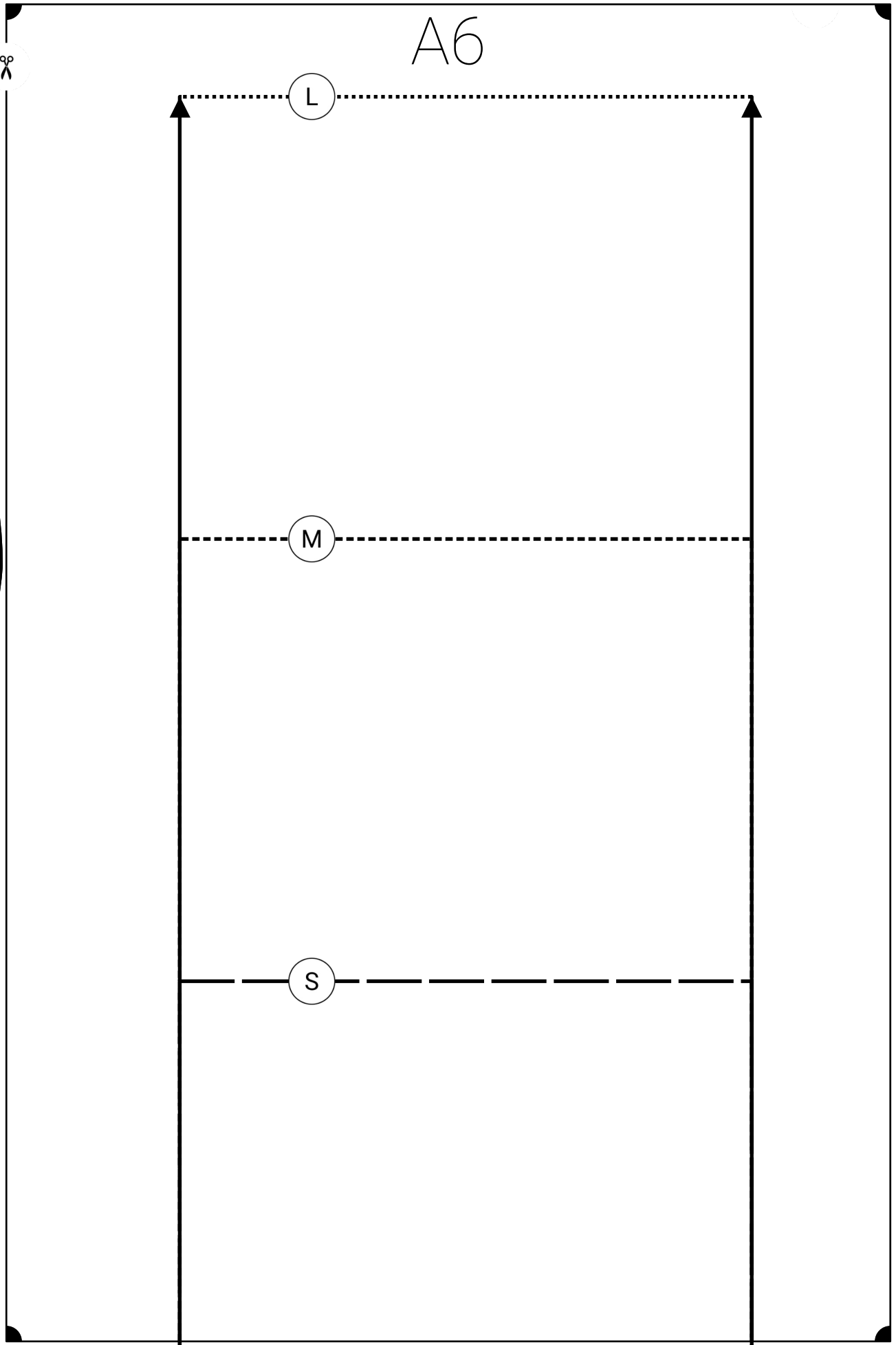
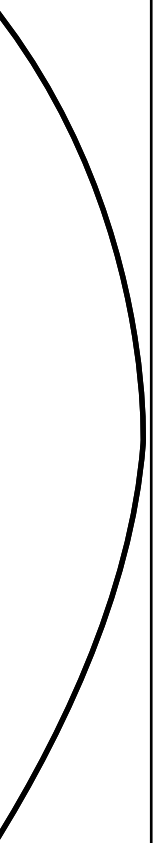

B1



Shorts

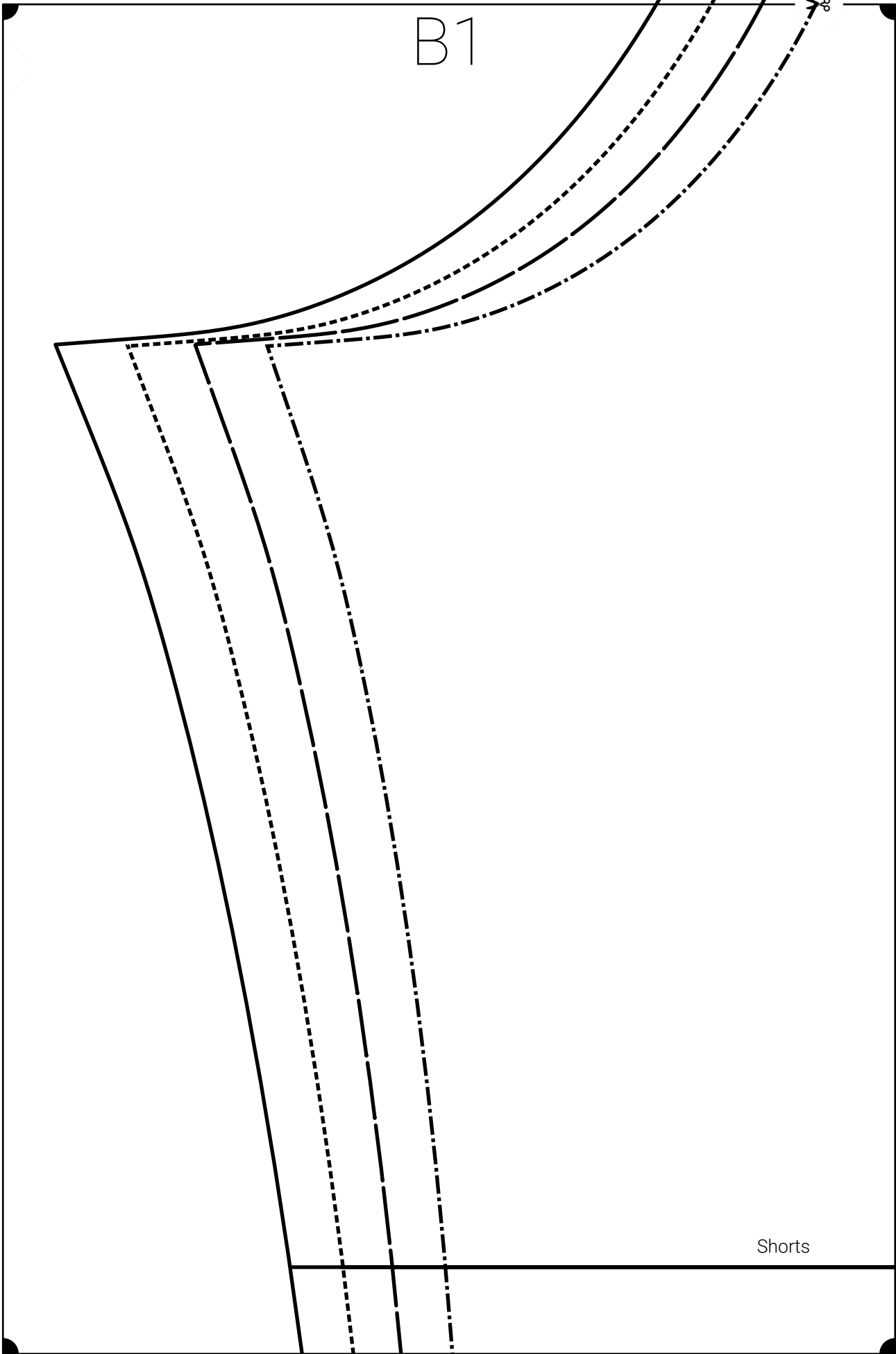

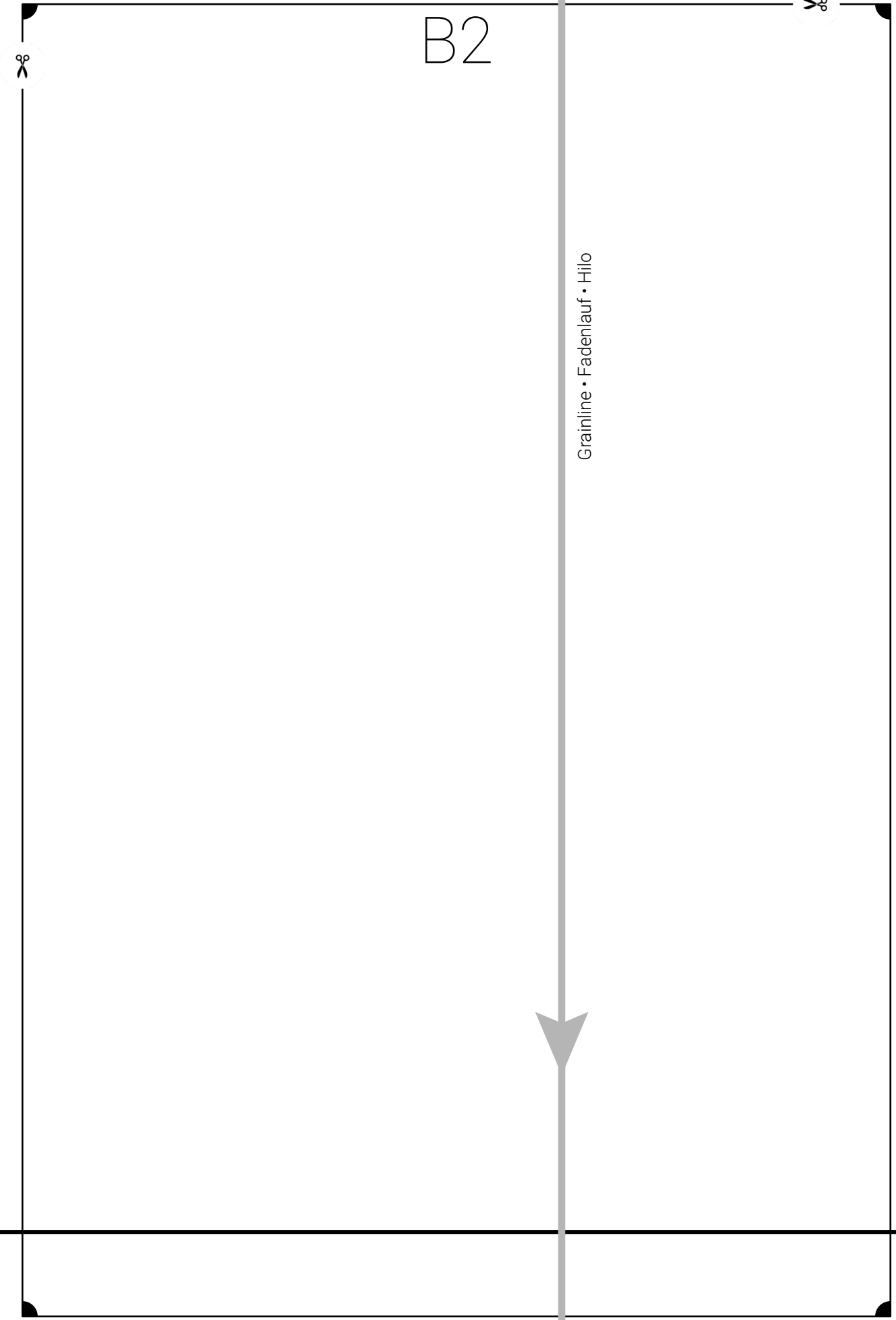

B2

Grainline • Fadenlauf • Hilo



rts

B3

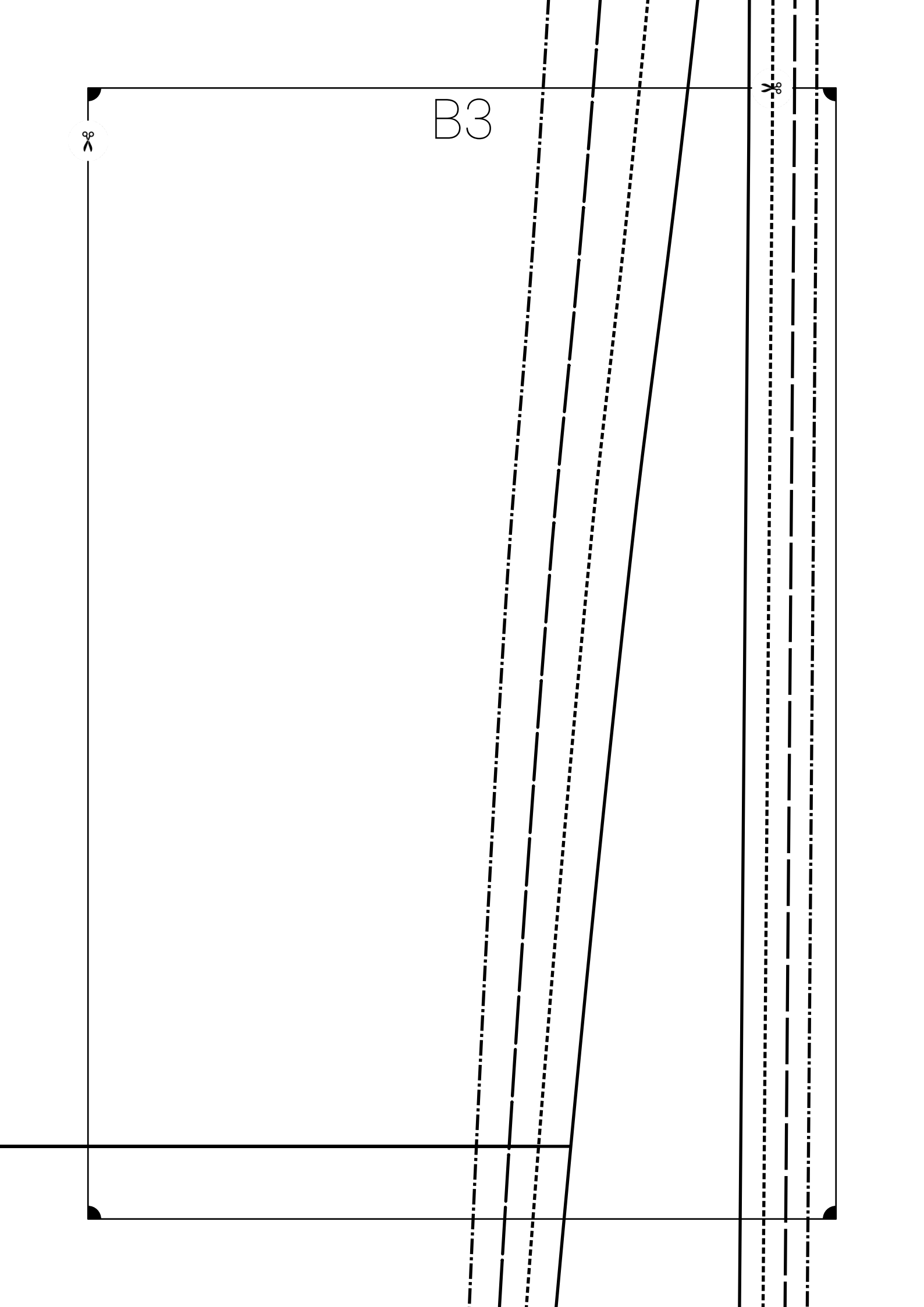

B4

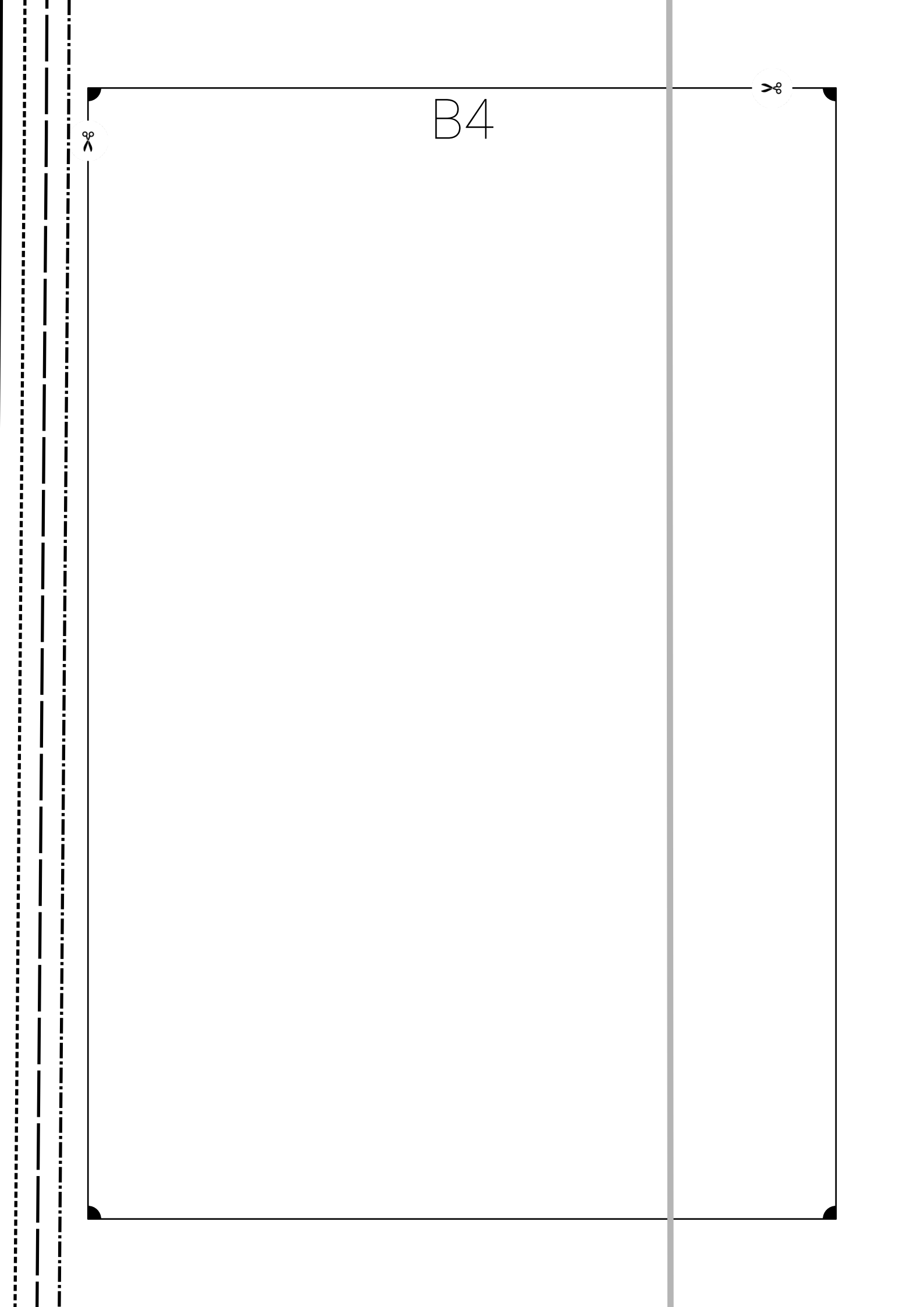

B5

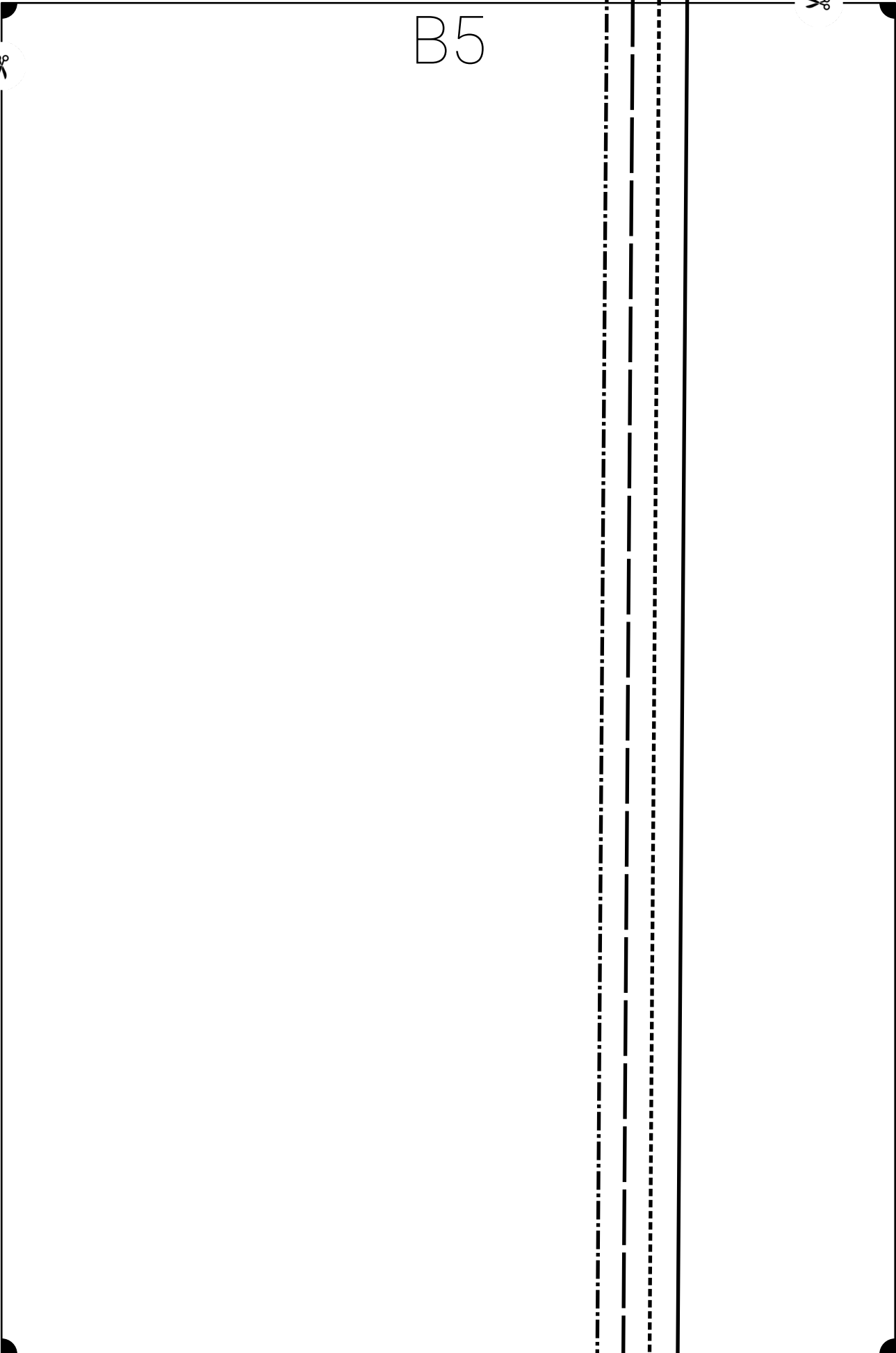

B6

XS

Measure length for safety
Zur Sicherheit Länge messen
Medir el largo para la seguridad

4

Pants • Hose • Pantalón | tr-0002

Waistband 1x
Bund 1x
Cintura 1x



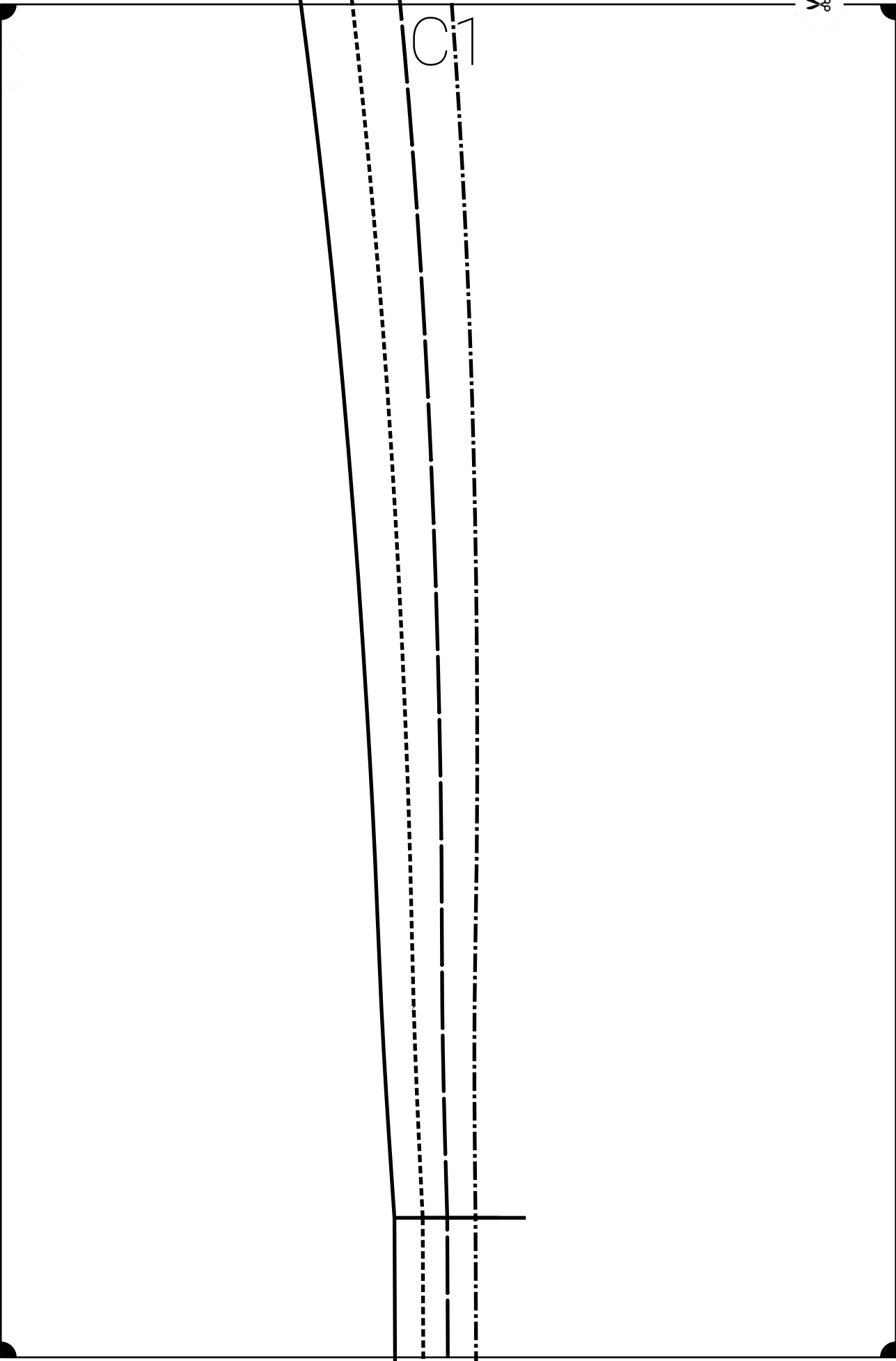

C1



C2



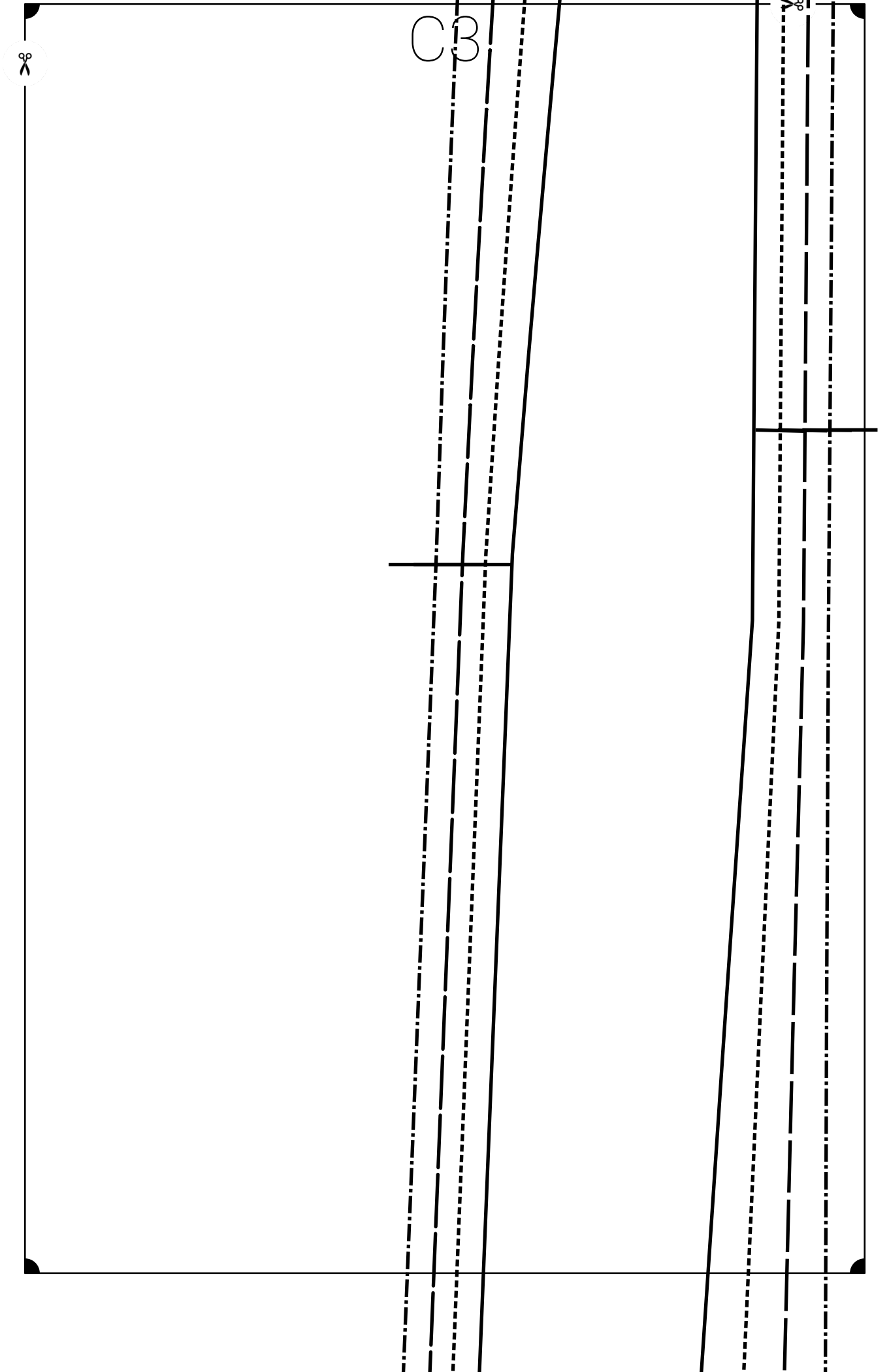

C4

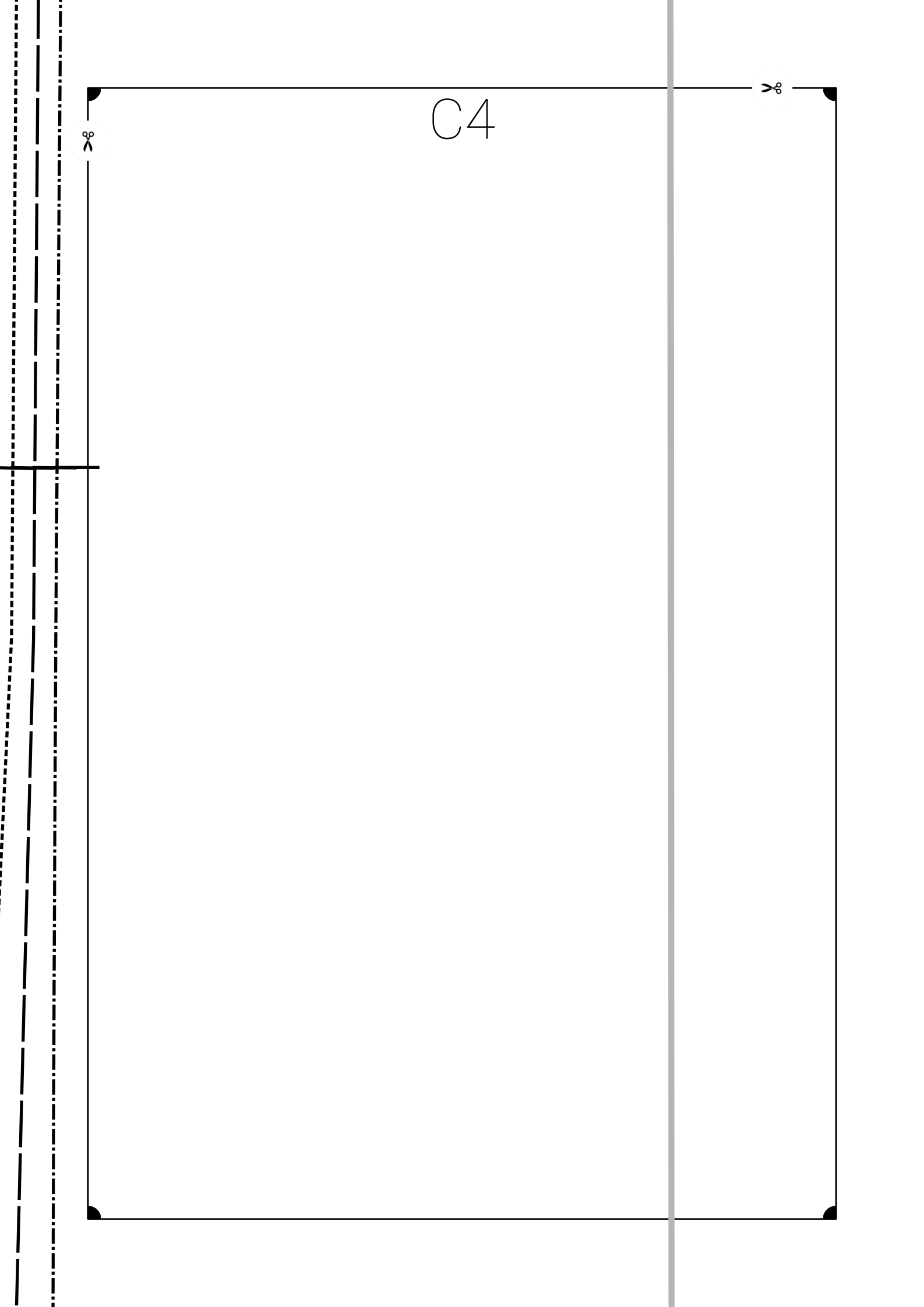

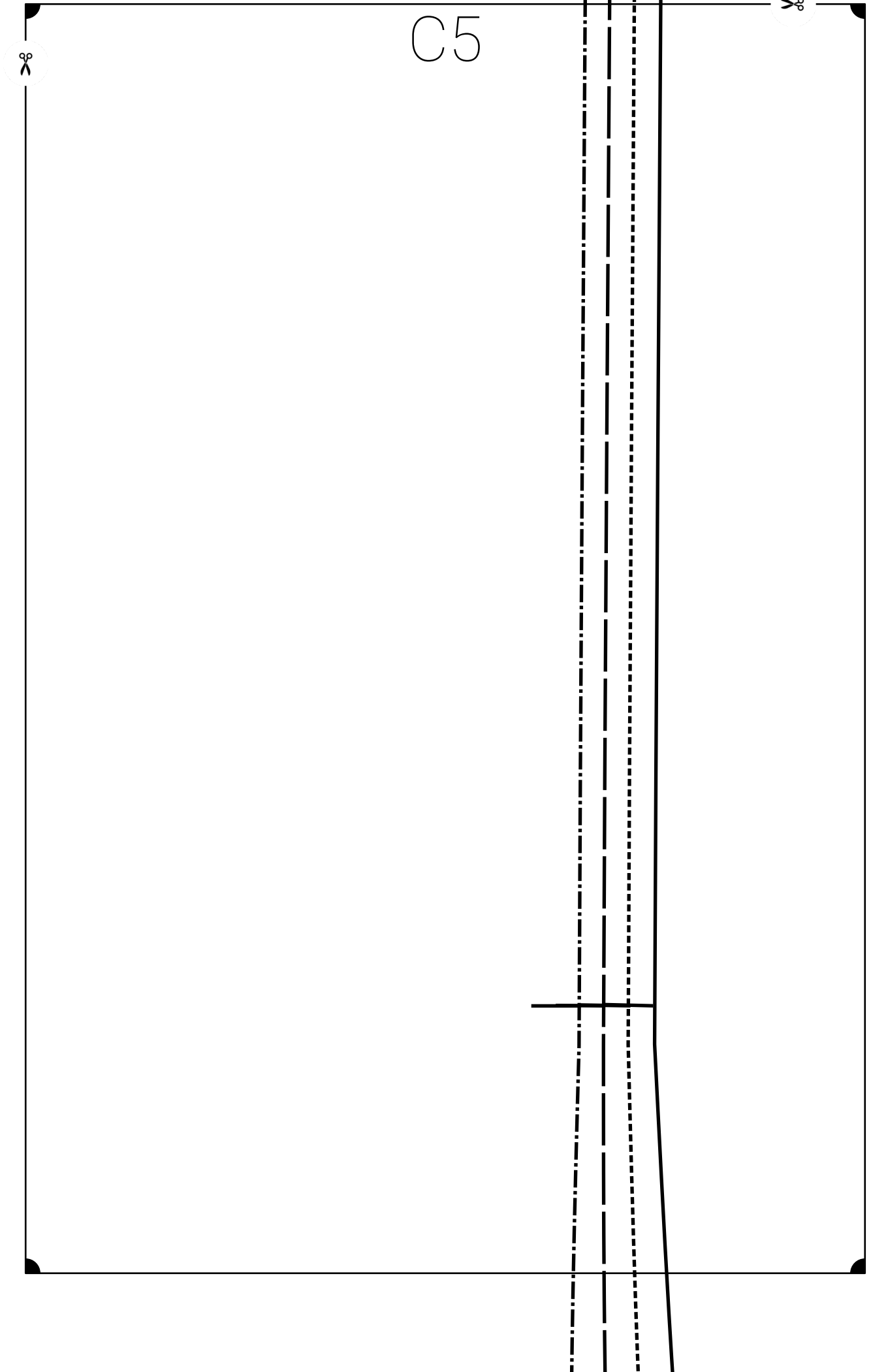



C6

Grainline • Fadenlauf • Hilo

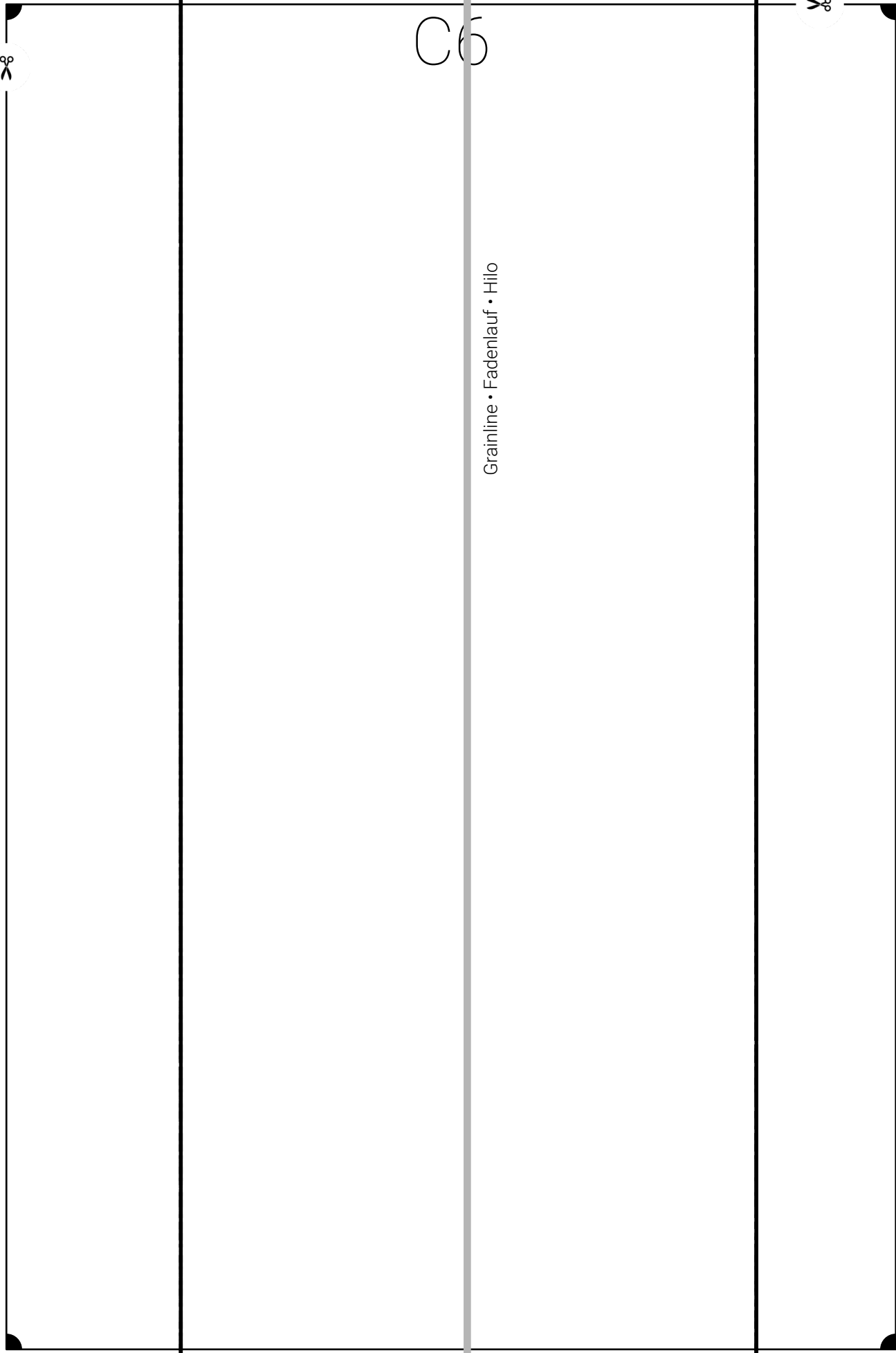

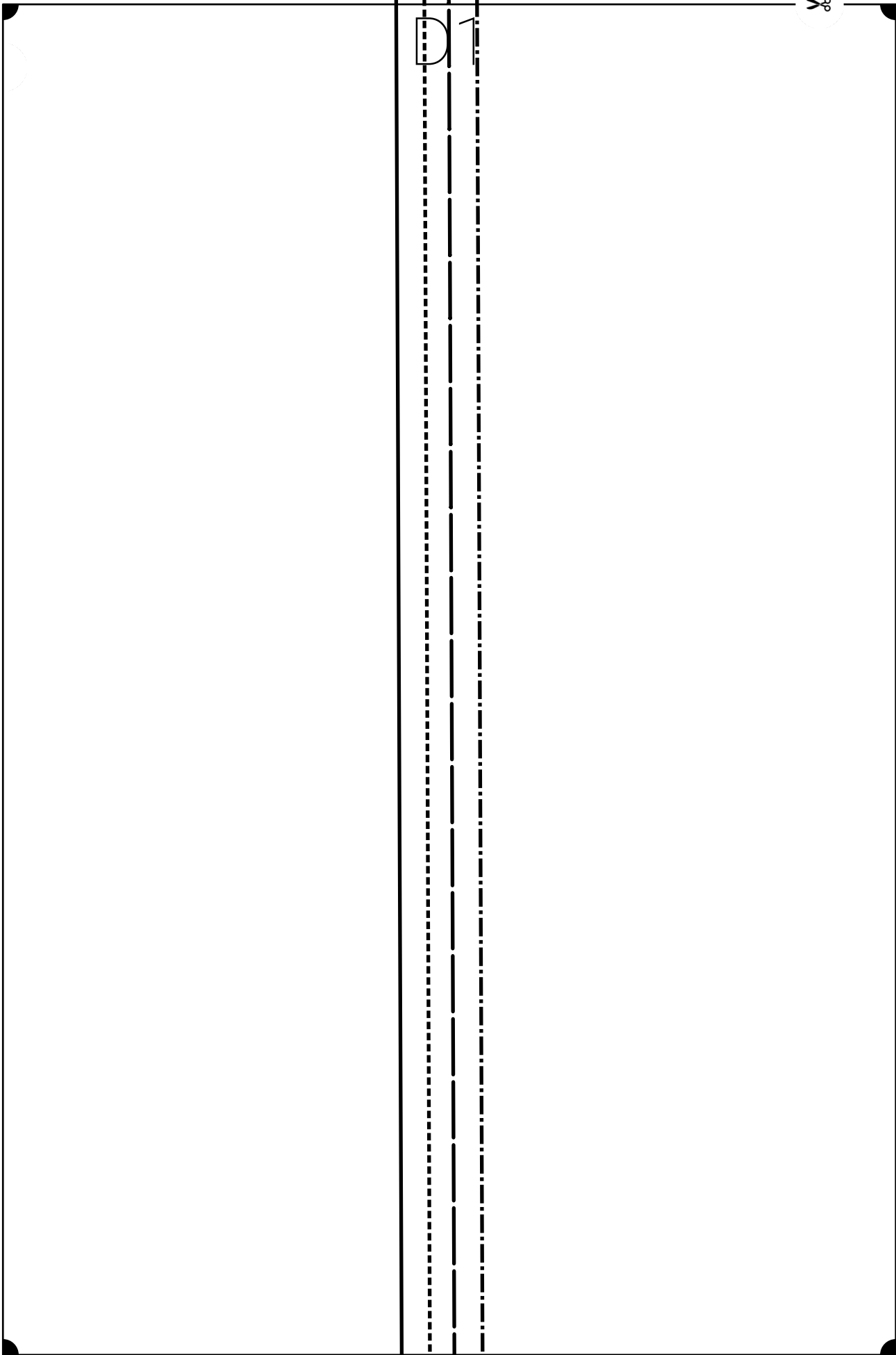

D¹



D2



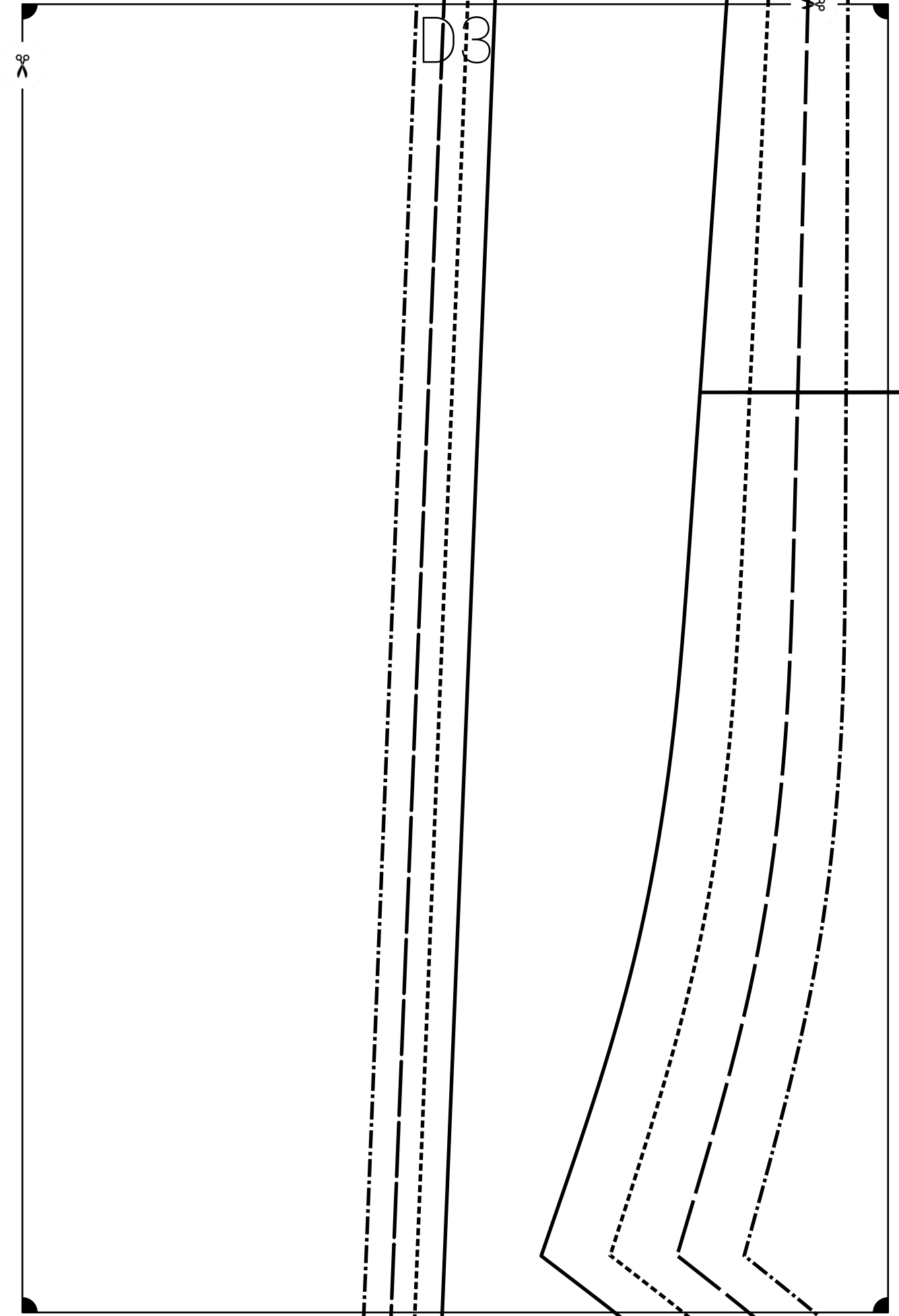

D3



D4



Grainline • Fadenlauf • Hilo



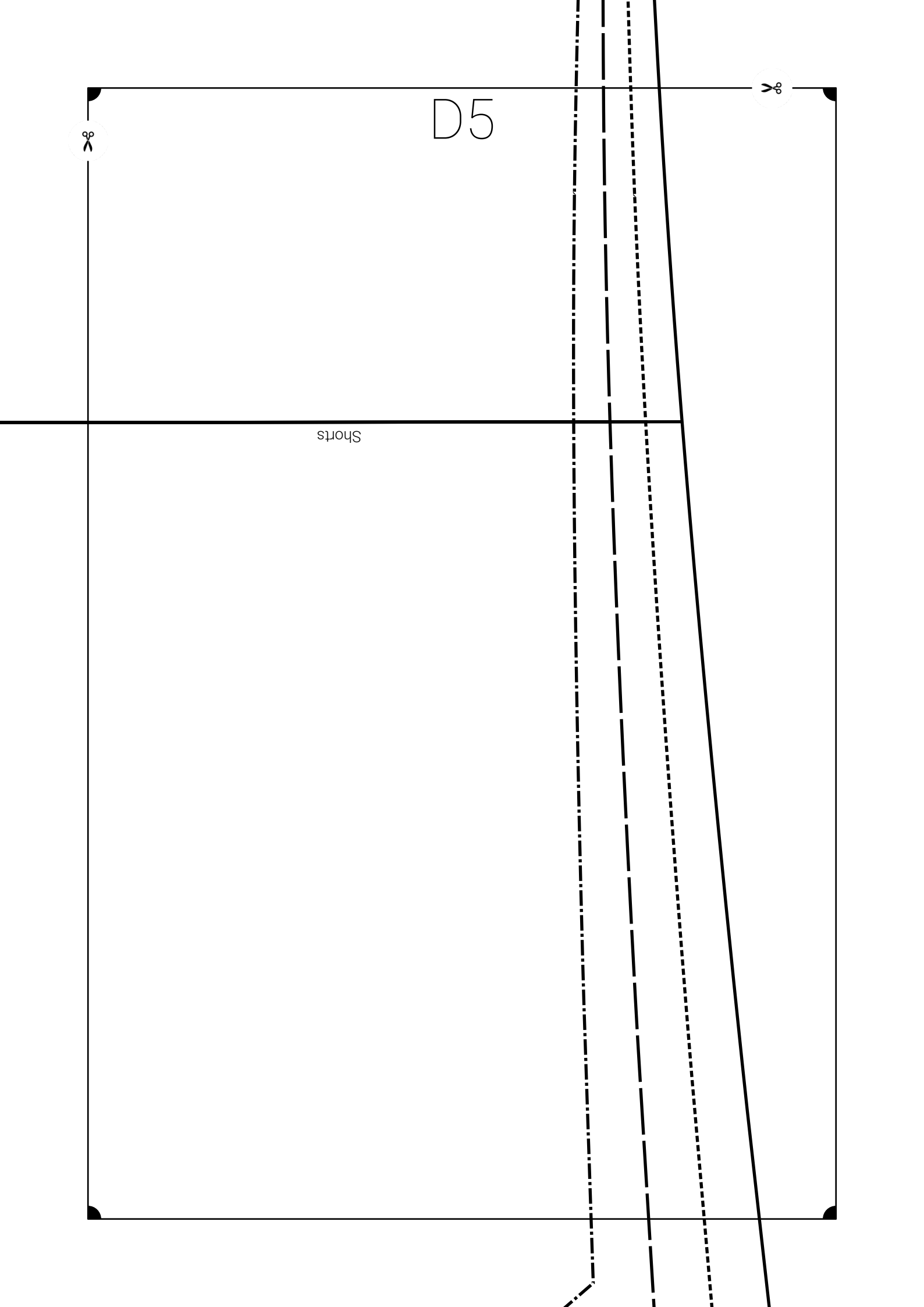

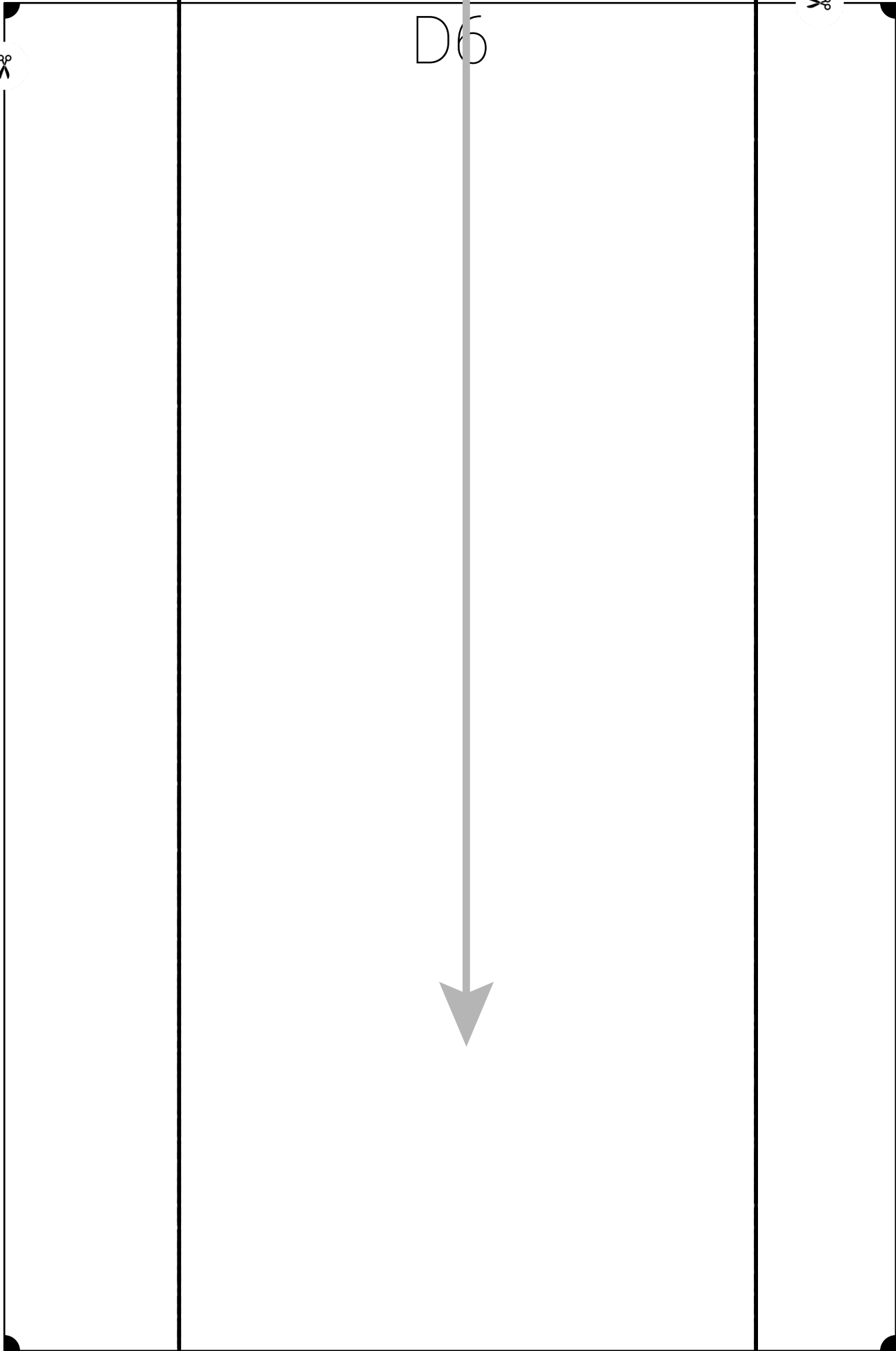

D6





EN

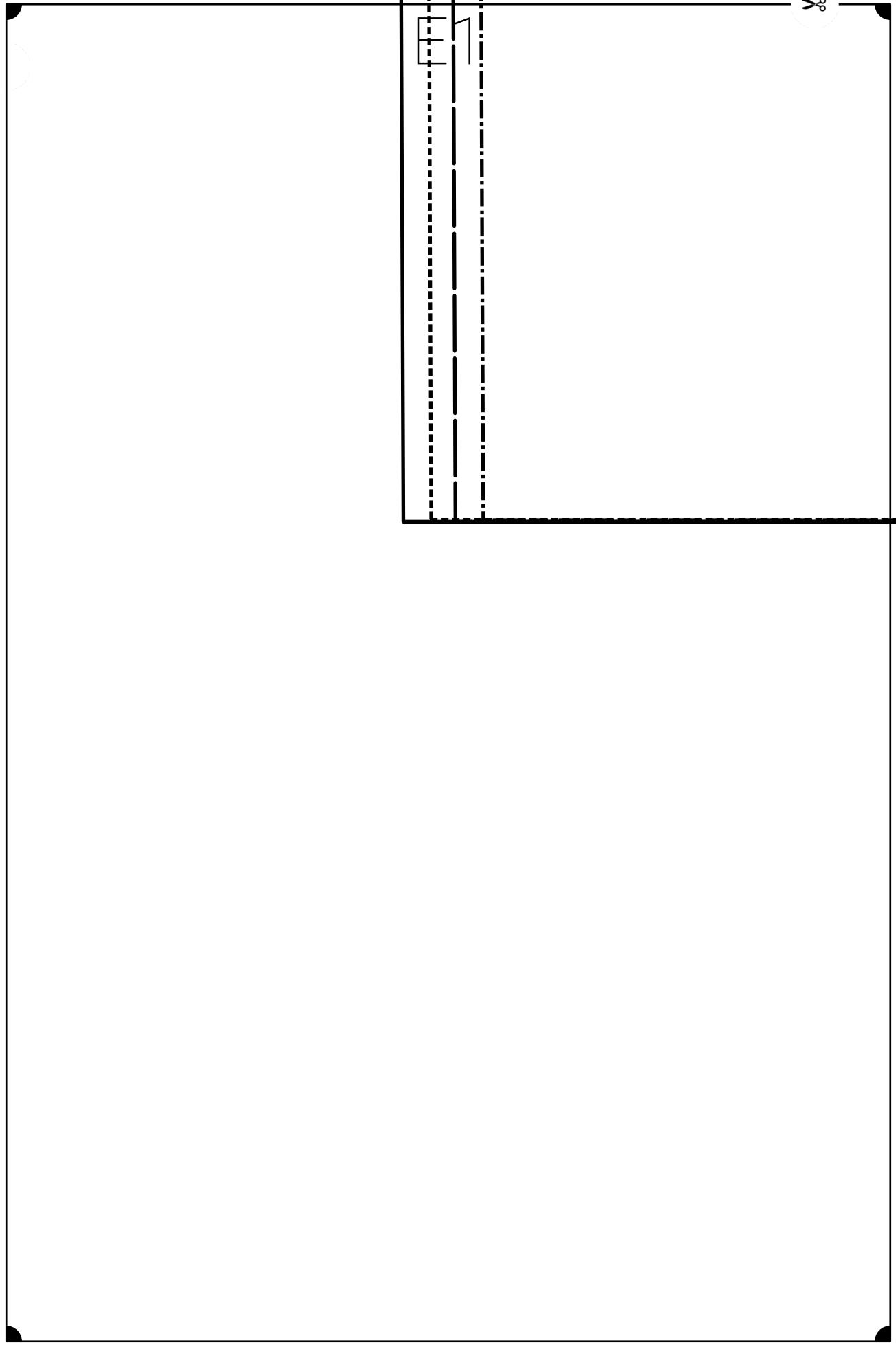

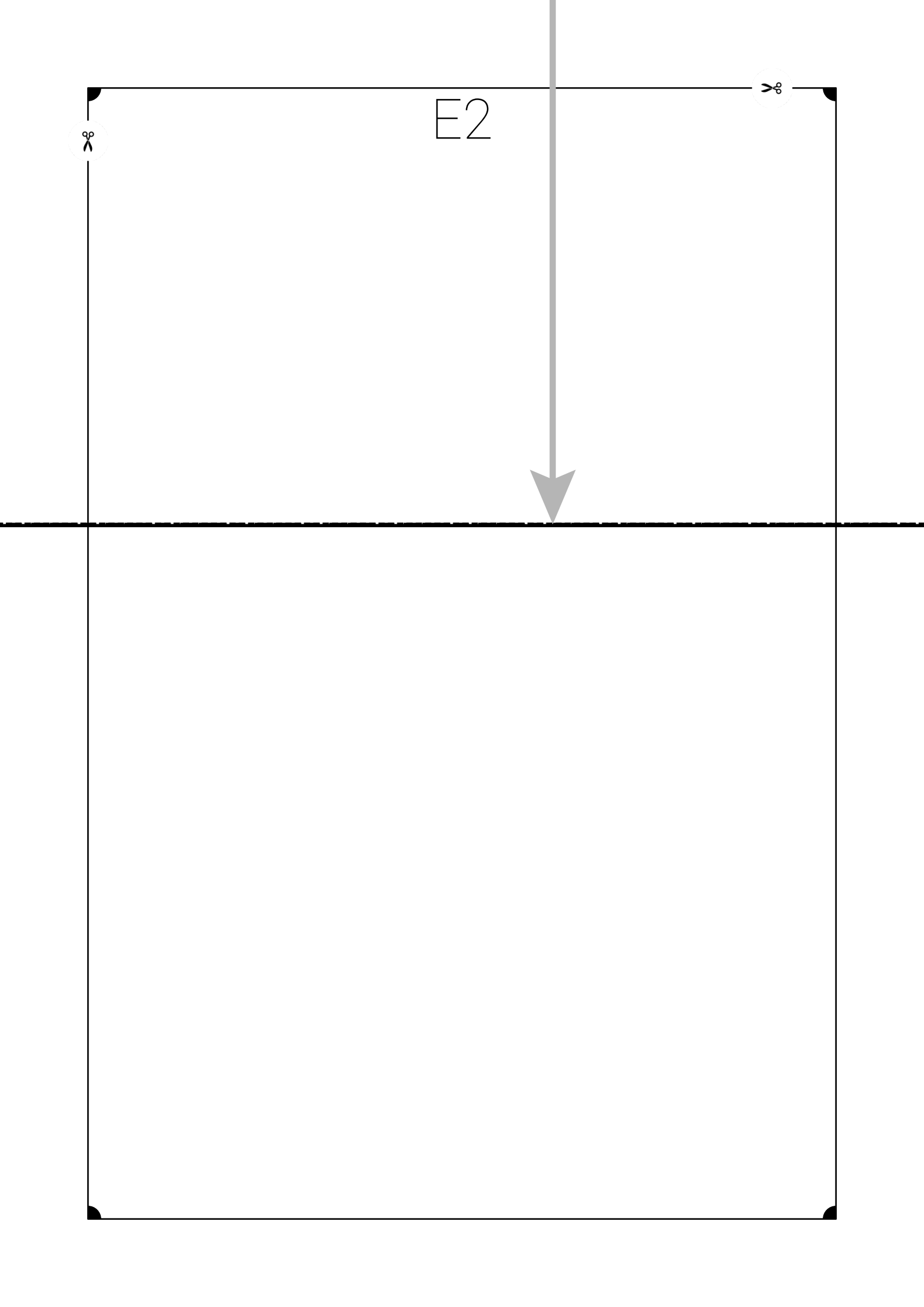

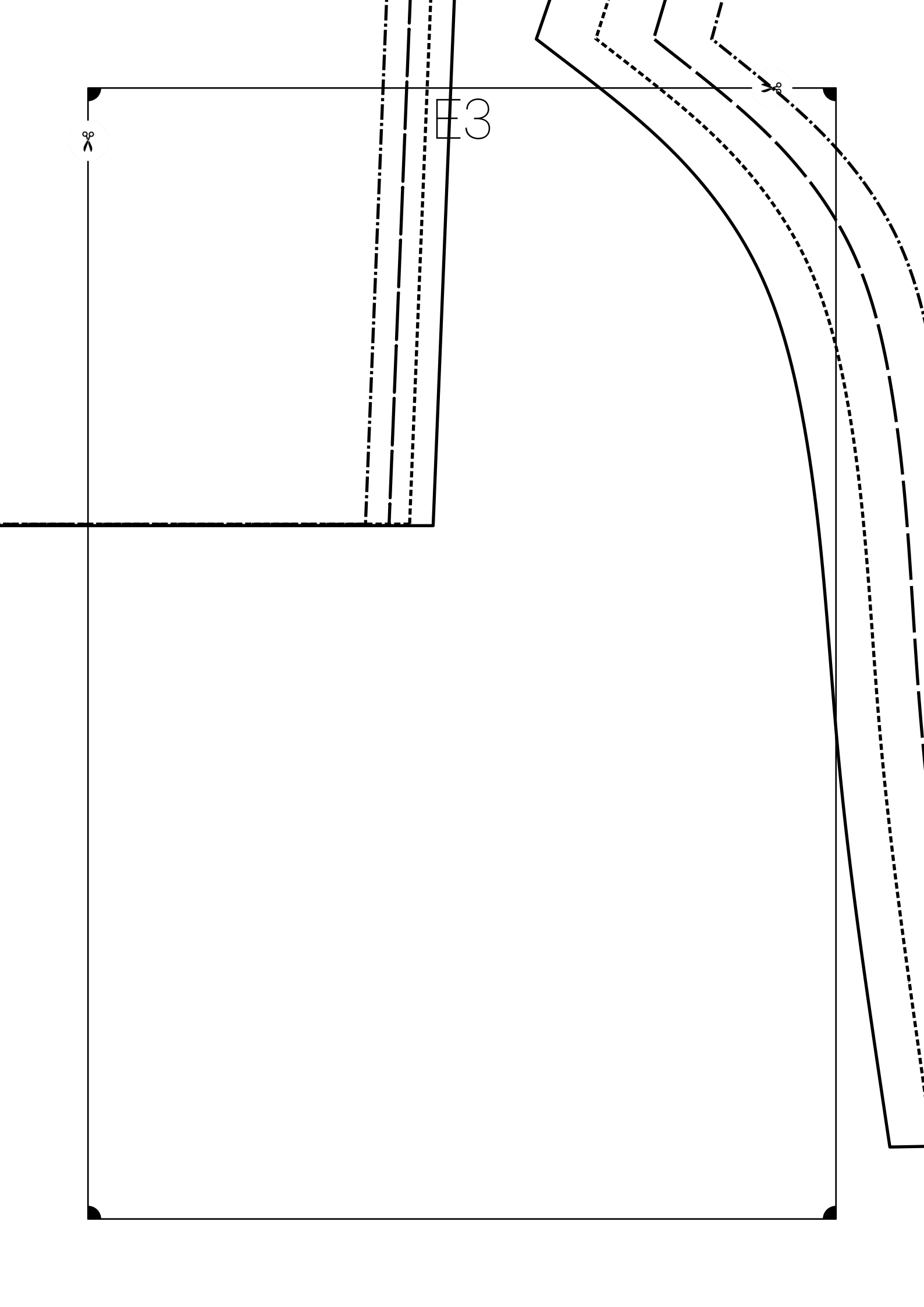

E3



E4

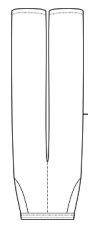

Pants • Hose • Pantalón | tr-0002

Front 2x
Vorderteil 2x
Frente 2x

1

S

S

M

L

E5



SX

S

M

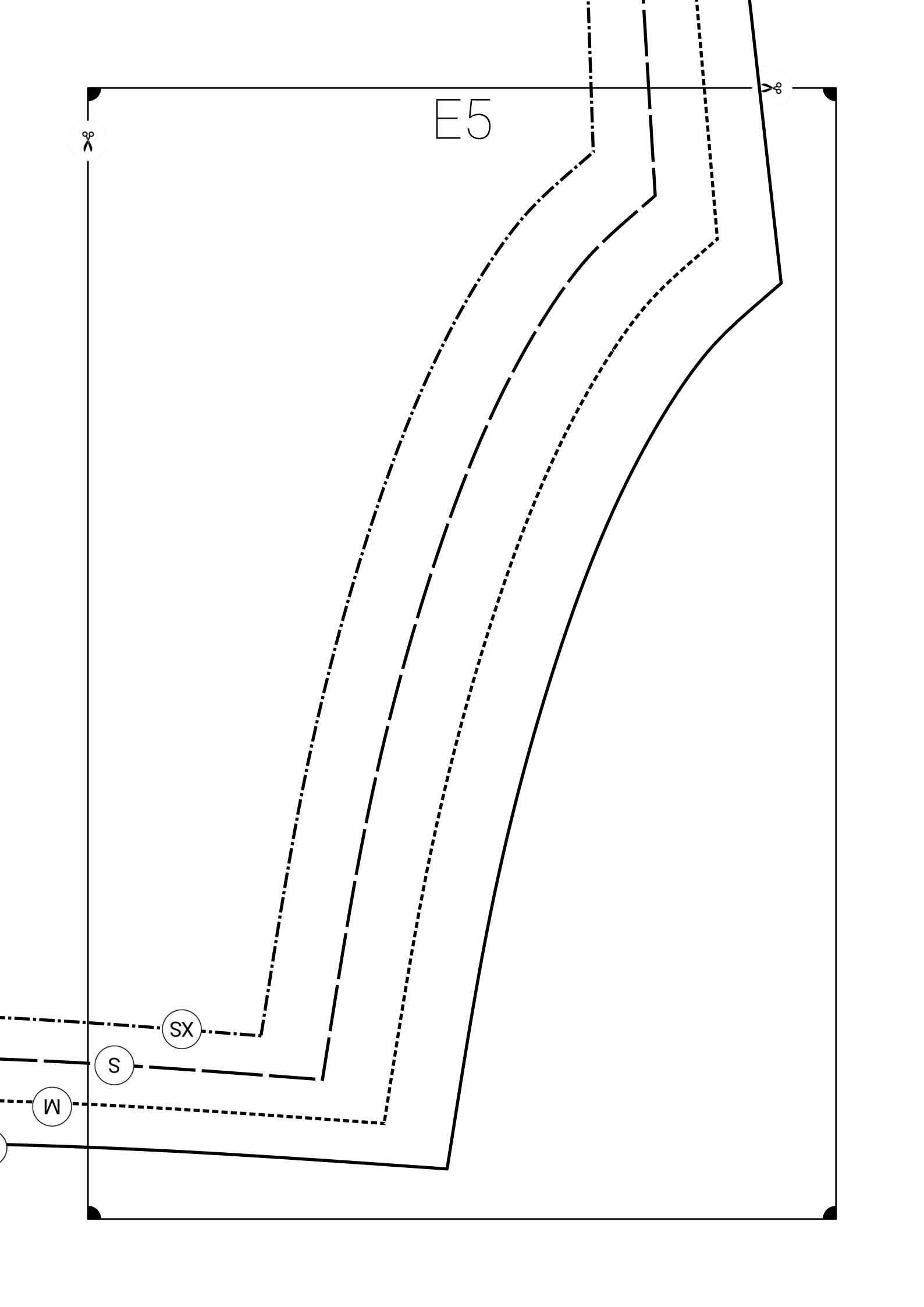

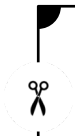

E6

